



SPITZ
VET CARE

endoscopy



index.

diagnostic endoscopy.	4 - 39
arthroscopy.	40 - 83
laparoscopy.	84 - 111
devices.	112 - 135





passion for animals.

Spitz VetCare is your competent partner for endoscopic technologies. We provide all for your minimal invasive approach, from laparoscopy, arthroscopy to diagnostics. From needle holders to high-resolution 4K UHD cameras or customized special products, we have an exclusive product portfolio for your needs.

Dr. med vet Markus Spies has been in veterinary medicine for 20 years, as a clinician and in industry. SPiTZ VetCare was founded in 2021 as a subsidiary of the Tuttlingen-based family company RZ Medizintechnik GmbH.

And that is what Spitz VetCare is all about: The clinical experience and passion of veterinarians combined with experience in developing and manufacturing medical technology make Spitz VetCare a strong partner. For us, veterinary medicine is not just a subsidiary of human medicine, but an important part of modern medical technology.



diagnostic endoscopy.



- Different scopes and sheaths for all kind of indications
- For diagnosis and treatment in all natural orifices
- Wide range of flexible, semiflexible and rigid instruments
- Dedicated equipment for the Rhinoscopy, Laryngoscopy, Otoscopy or Vaginoscopy and Cystoscopy
- Urethro-Cystoscopes for the artificial insemination

Mobile endoscopy becomes possible with this High Definition camera that allows endoscopic examination with all required parts in one complete set. Integrated illumination and a high-performance camera head, powered by an external Desktop-Computer or Laptop via USB 3.0 makes examination and clinical surgery possible.

- Full HD (1920 x 1080) recording function (images / video)
- Powered by USB connection (USB 3.0 required)
- Long-life LED illumination
- Programmable camera head with adjustable brightness
- Easy software installation and interface (Software incl. patient management/storage)
- Lightweight, ready-to use design



300-001-480
FULL HD CAMERA SET
consisting of:

- A Camera head
- B Endoscope coupler
- C Light source
- D Suitcase
- E Software



High-Performance
HD Camera Head



Programmable buttons and
adjustable brightness button

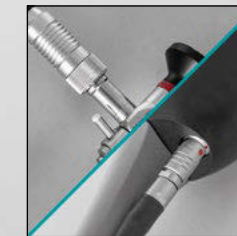

Lightsource can be connected
directly to Endoscope and
camera head



Just a USB 3.0 port is
required





Otoscope, 5 Charr., \varnothing 4mm, 65mm working length
0° 410-005-000

Semi-rigid Instruments

- 280mm working length
- 5 Charr.



Stone Grasping Forceps, double action
253-200-128

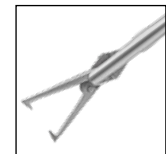

Large Stone Grasping Forceps, double action
253-200-228



Biopsy Forceps, double action
253-200-328



Cotton Applicator, rough spiral end, \varnothing 1.5mm
180mm 160-412-180



Farrell Cotton Applicator, triangular, \varnothing 0.9mm
120mm 160-426-120
140mm 160-426-140



LuerLock tube connector with stopcock
300-011-179



LuerLock one-way stopcock
300-011-515

ENT
Otoscopy

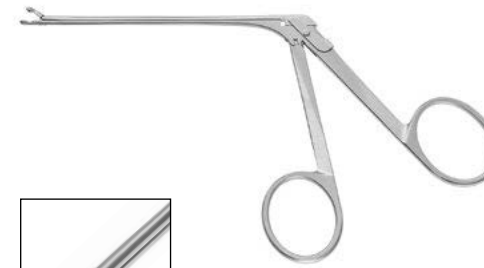

Hartmann-Herzfeld Ear Forceps, straight,
87mm working length
2.5mm spoon 410-338-136

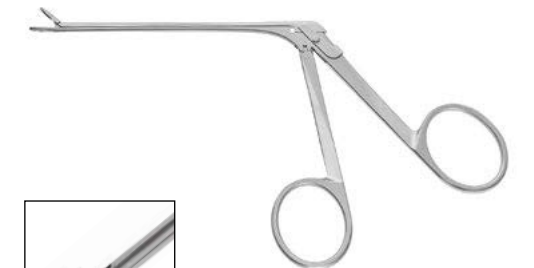

Struempel Ear Forceps, straight,
87mm working length
2.5 x 7.0mm 410-338-134



Ormerod Micro Cupped Forceps, straight,
round cup, 80mm working length
4.0 x 1.7mm 410-423-000



Micro Aural Forceps with tubular shaft, straight
80mm working length
0.8 x 3.5mm 410-330-000



Hartmann Aural Forceps, straight, serrated
1 x 8mm 410-210-085



Troeltsch Aural Tissue Forceps, 1 x 2 teeth, knee bent

125mm 410-377-120

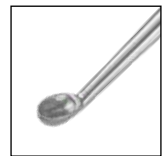

House Curette, sharp, double ended, oval cups, strongly curved, 1.0 x 1.2mm

150mm 410-330-000



Williger Double Curette, oval/oval #0/1 (Ø 3.0/3.5mm)

140mm 210-216-001



ENT Rhino/Naso

Rhinoscopy / Nasopharyngeal Endoscopy

Equipment and instruments for the visualization in the nasopharyngeal area

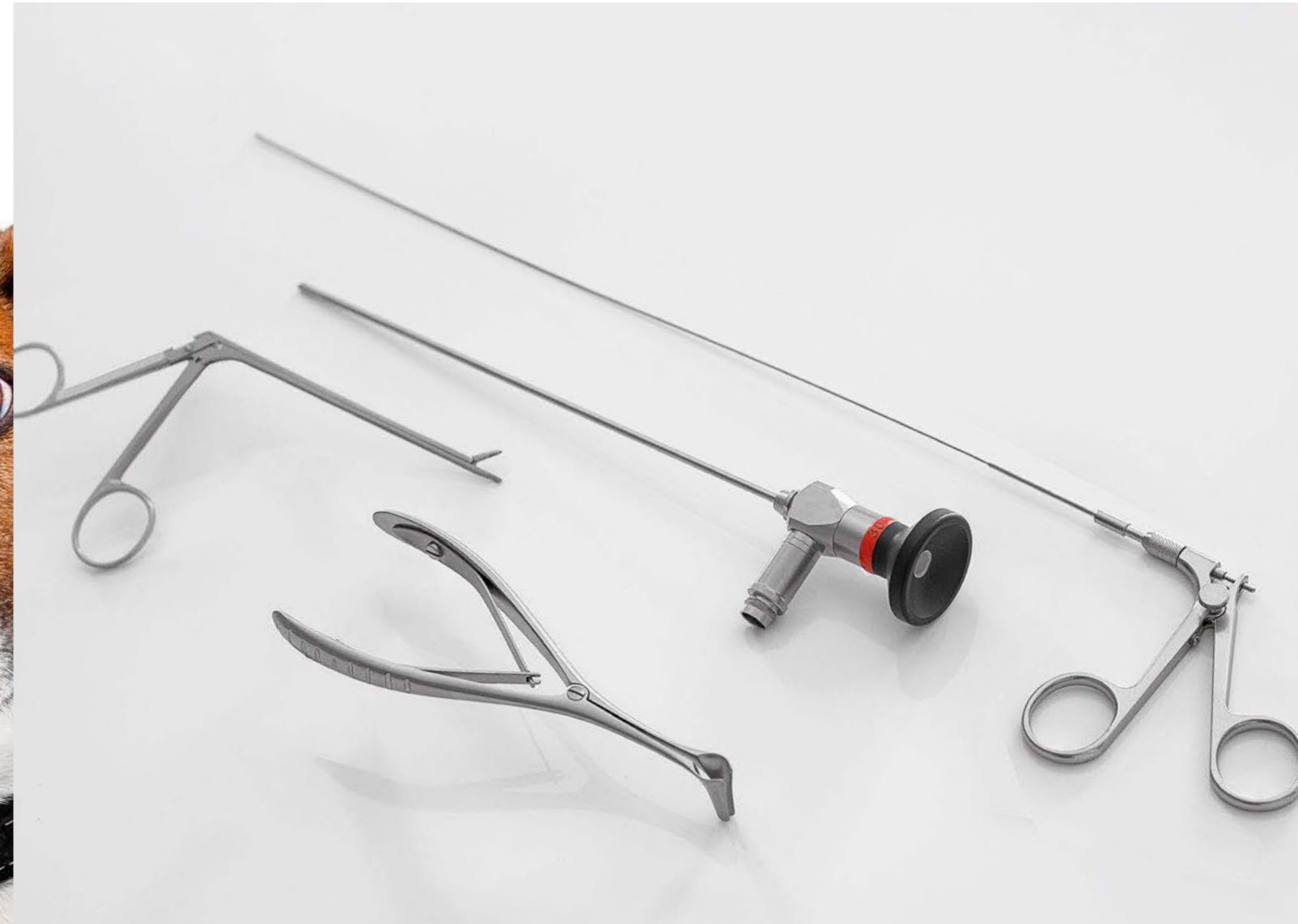

Set for
DOGS
Ø2.7mm



Sinuscope, Ø 2.7mm, 180mm working length

0°	252-127-000
30°	252-127-030
70°	252-127-070

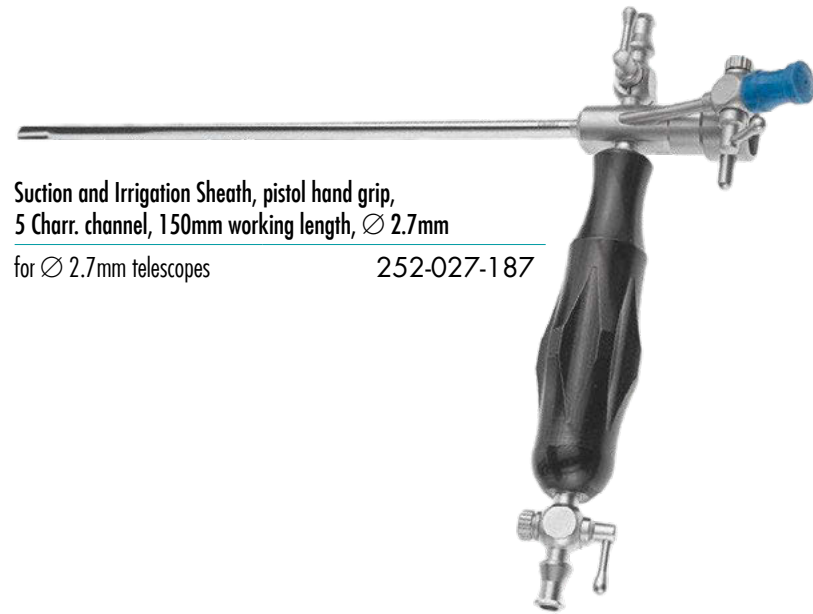

Suction and Irrigation Sheath, pistol hand grip,
5 Charr. channel, 150mm working length, Ø 2.7mm

for Ø 2.7mm telescopes 252-027-187

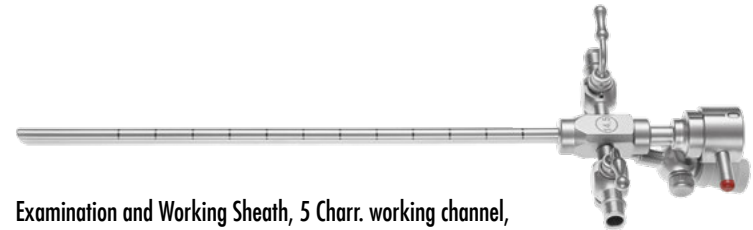

Examination and Working Sheath, 5 Charr. working channel,
150mm working length, Ø 2.8mm

for Ø 2.7mm telescopes 252-027-185



Cleaning Brush, flexible, 3mm diameter, 100mm
length, for use in 2.0 - 2.6mm working channels

253-961-103

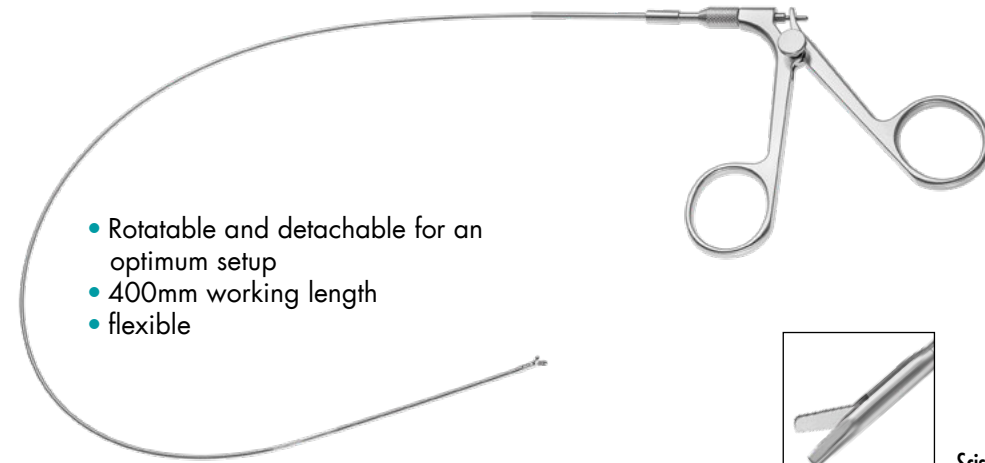

- Rotatable and detachable for an optimum setup
- 400mm working length
- flexible



Scissors, single action

5 Charr.

351-100-105



Grasping Forceps, serrated jaws, double action

5 Charr.

351-114-105



Biopsy Forceps, oval cup, double action

5 Charr.

351-120-105

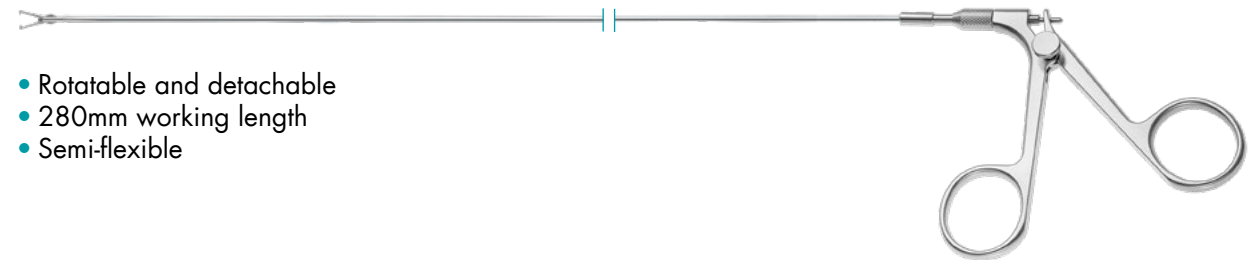

- Rotatable and detachable
- 280mm working length
- Semi-flexible

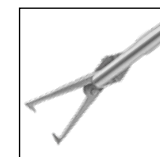

Large Stone Grasping Forceps, double action

5 Charr.

253-200-228

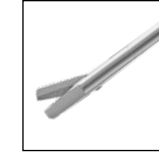

Scissors, single action

5 Charr.

253-200-228

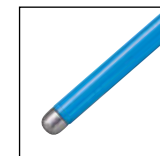

Ball Electrode, monopolar, 530mm length

5 Charr.

253-370-005

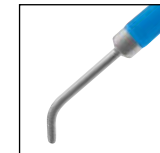

Needle Electrode, monopolar, 530mm length

5 Charr.

253-371-005

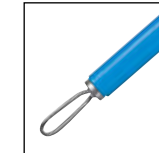

Loop Electrode, monopolar, 250mm length

5 Charr.

253-372-005





Mini Scope, Ø 2.0mm, 120mm working length

- 0° 253-221-000
- 30° 253-221-030

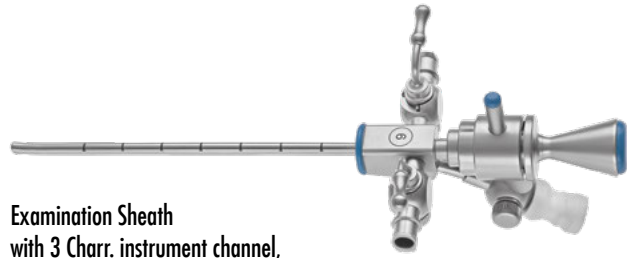

Examination Sheath with 3 Charr. instrument channel, atraumatic tip

- 7.5 Charr. / 2.5mm 253-200-007
- 9 Charr. / 3mm 253-200-009

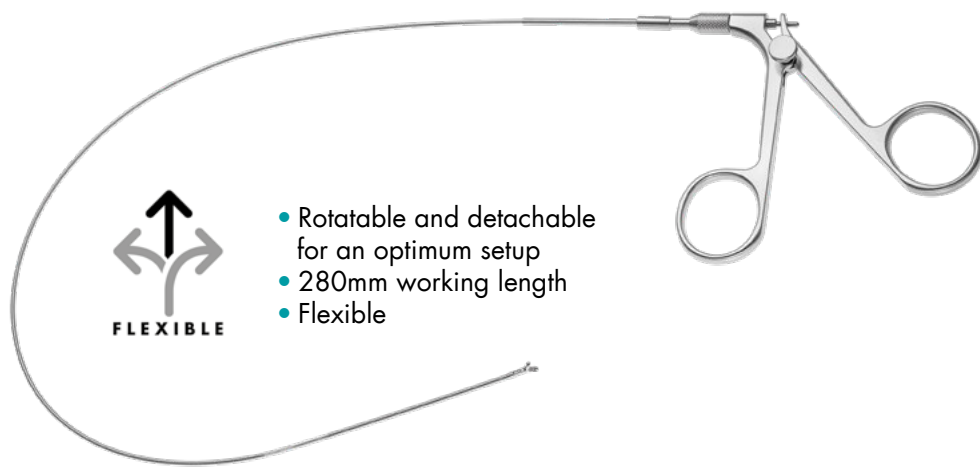

- Rotatable and detachable for an optimum setup
- 280mm working length
- Flexible



Alligator Grasping Forceps, double action

- 3 Charr. 253-202-003



Biopsy Forceps, double action

- 3 Charr. 253-204-003

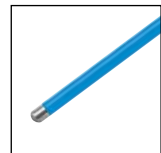

Ball Electrode, monopolar, 250mm length

- 3 Charr. 253-370-253

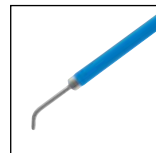

Needle Electrode, monopolar, 250mm length

- 3 Charr. 253-371-253



Set for
CATS
Ø2.0mm



Visualization with minimal equipment

LED Portable Lightsource, with 1700mAh charger

300-001-183

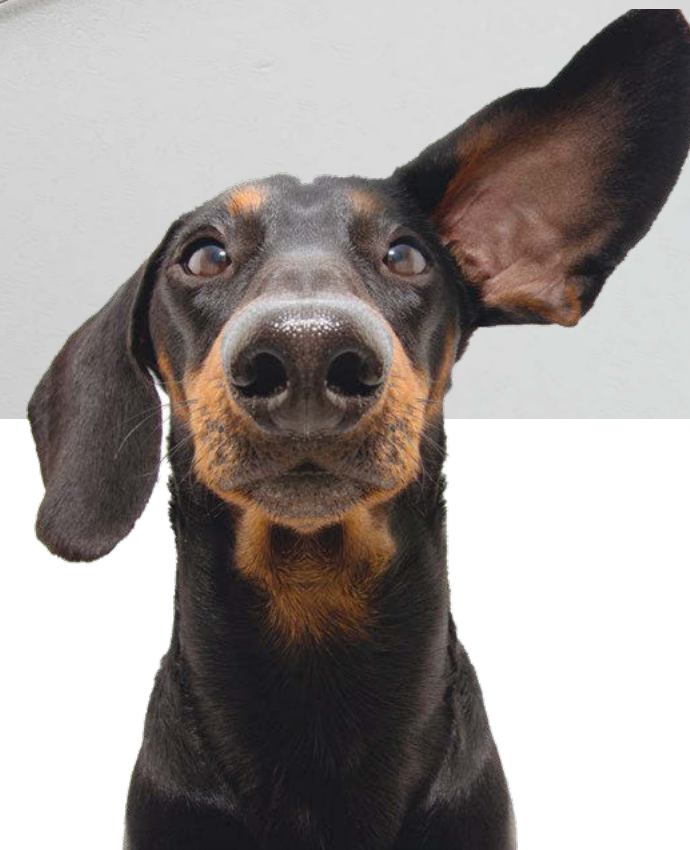
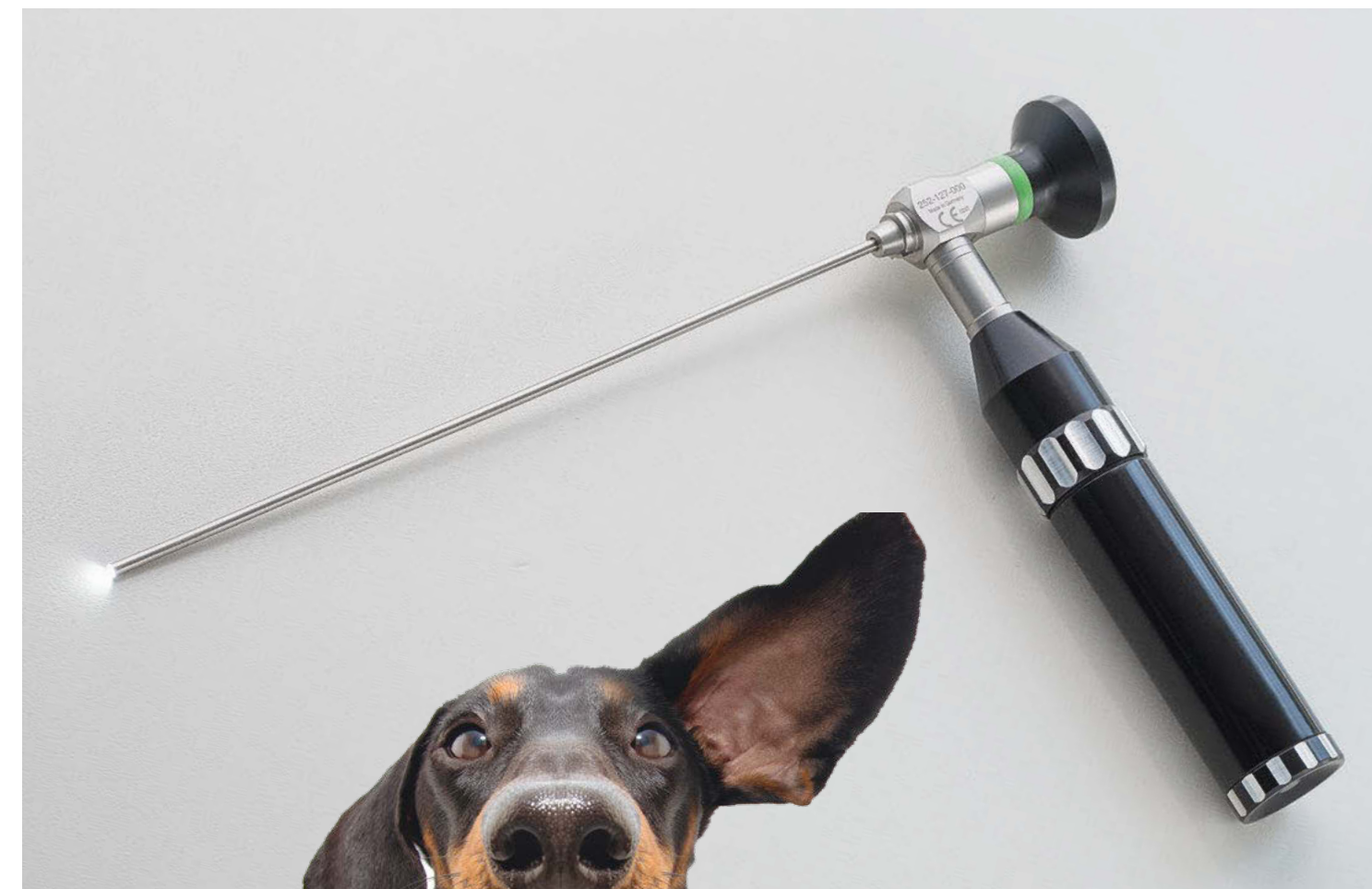

Instruments for endoscopically assisted and open treatment



Halle-Tieck Nasal Speculum, screw joint, 130mm total length
17.5mm blade length 420-140-135



DJ Forceps, double action
7 Charr. **FLEXIBLE**
351-107-107



DJ Forceps, double action
7 Charr. **SEMI FLEXIBLE**
351-107-307

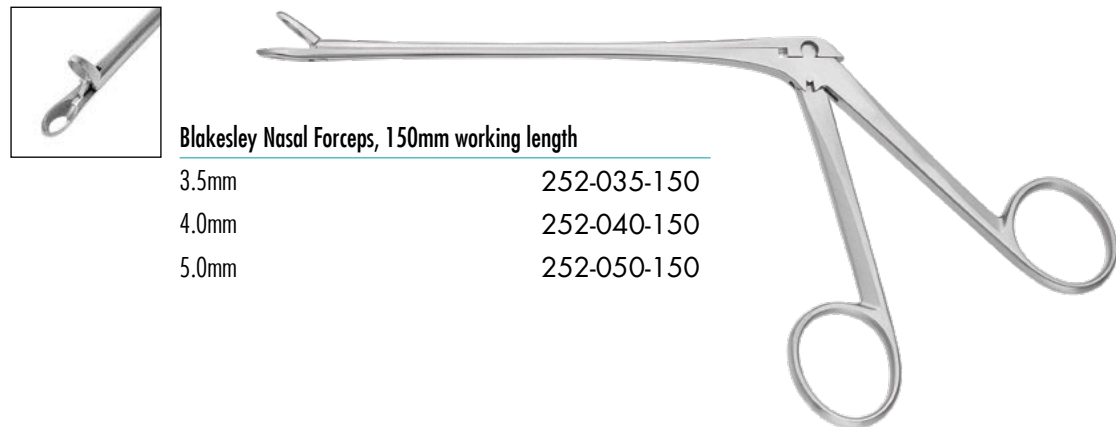

Blakesley Nasal Forceps, 150mm working length

3.5mm	252-035-150
4.0mm	252-040-150
5.0mm	252-050-150



Noyes Nasal Forceps, 115mm working length
fenestrated jaw 252-527-115



Biopsy and Grasping Forceps, delicate pattern,
140mm working length
3mm oval cup 252-503-140

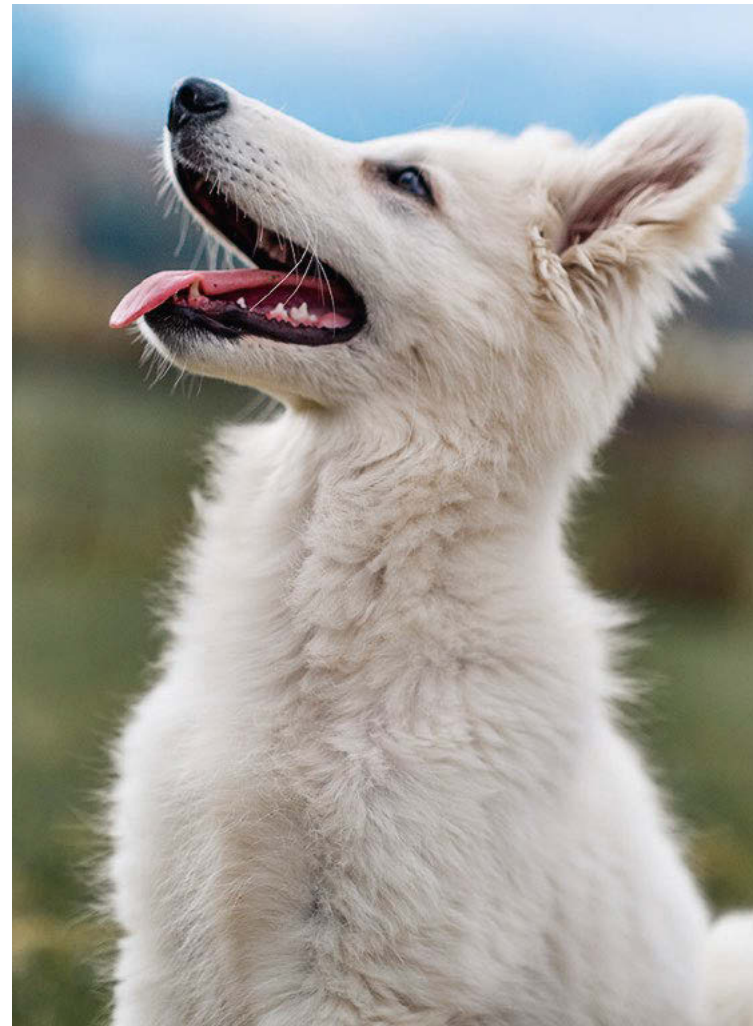
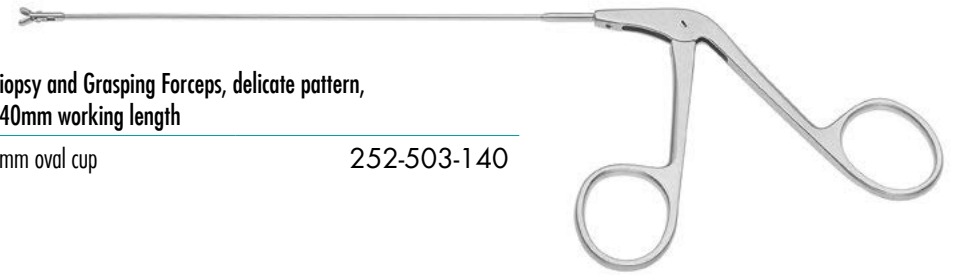

Struempel Nasal Forceps with
oval fenestrated cupped jaws
120mm working length
straight 252-031-120



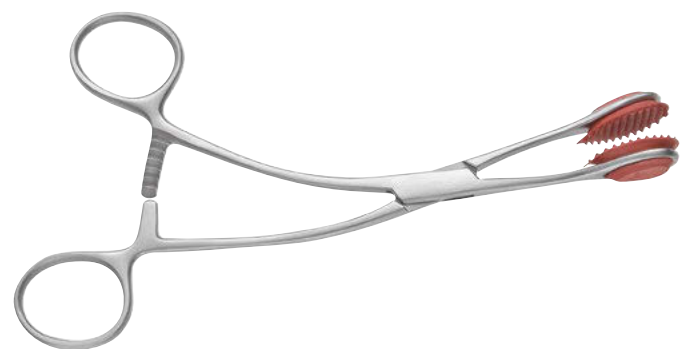

Young Tongue Holding Forceps

170mm 430-467-170



Hurd Elevator

230mm 430-522-230



Green Retractor, 20 x 23mm

220mm 170-319-220



Lange Choana Hook

230mm 420-413-230



Laryngeal mirror with hexagonal handle, 180mm

Fig. 00, Ø8mm	230-330-008
Fig. 1, Ø12mm	230-330-012
Fig. 3, Ø16mm	230-330-016
Fig. 5, Ø20mm	230-330-020



**Biopsy Forceps, vertical action, 70° curved up, 4 x 8mm
130mm working length**

70° curved up	252-670-120
110° curved backwards	252-770-120

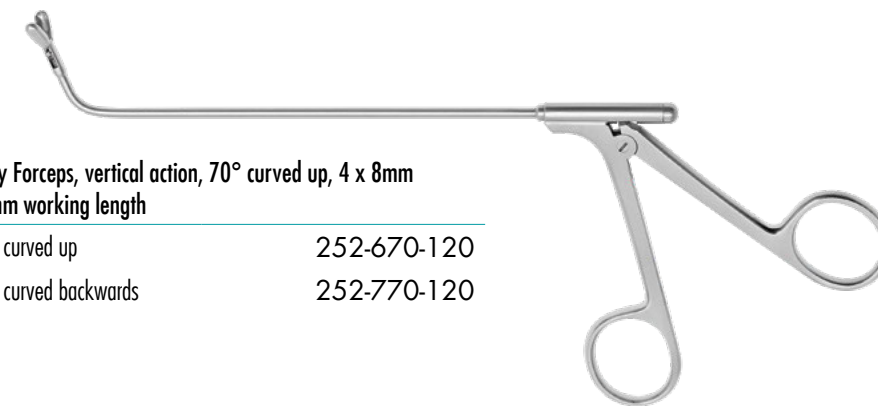

Bronchoscopy/ Esophago-Gastroscopy

Instruments and rigid scopes for the respiratory and gastrointestinal area

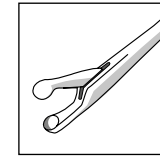
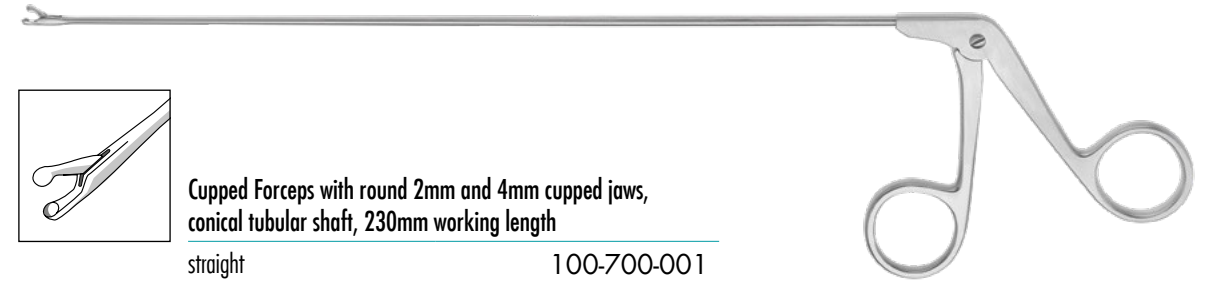
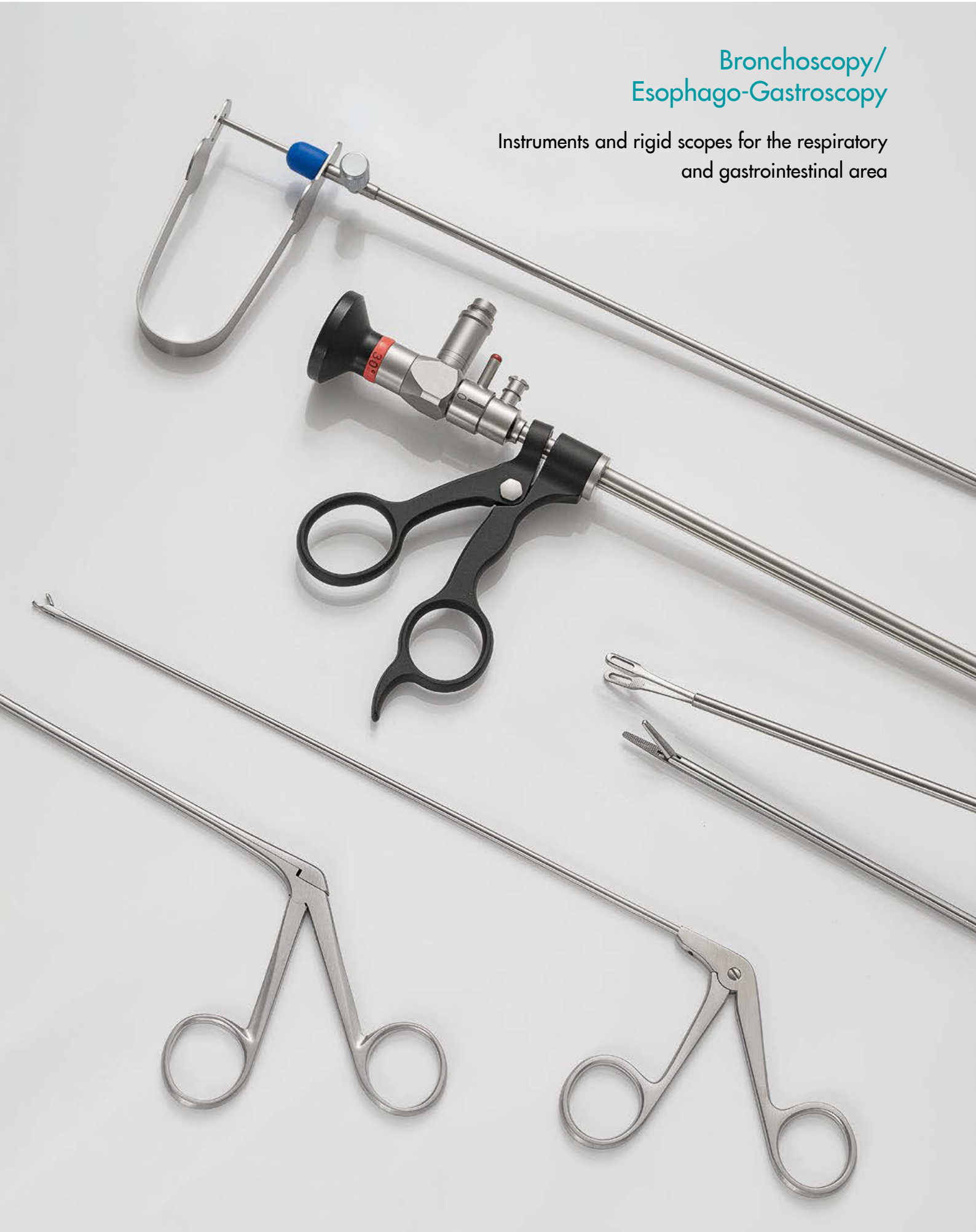

Cupped Forceps with round 2mm and 4mm cupped jaws, conical tubular shaft, 230mm working length
straight 100-700-001

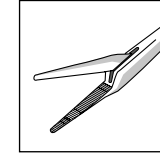

Alligator Forceps, standard model, conical tubular shaft 2mm, 230mm working length
straight, serrated 100-700-020

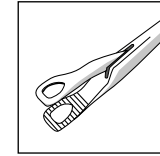

Alligator Forceps, standard model, conical tubular shaft 2mm, triangular jaws, 230mm working length
straight 100-700-026

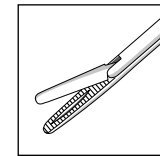
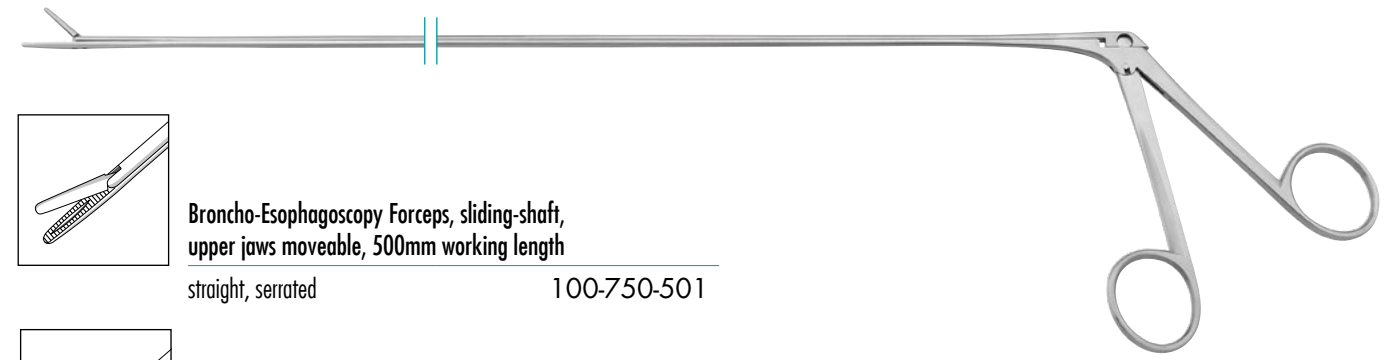

Broncho-Esophagoscopy Forceps, sliding-shaft, upper jaws moveable, 500mm working length
straight, serrated 100-750-501

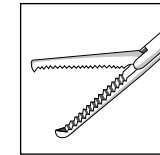

straight, 1x2 teeth 100-750-502

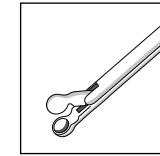

straight, cupped jaws 100-750-504

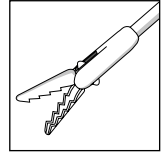
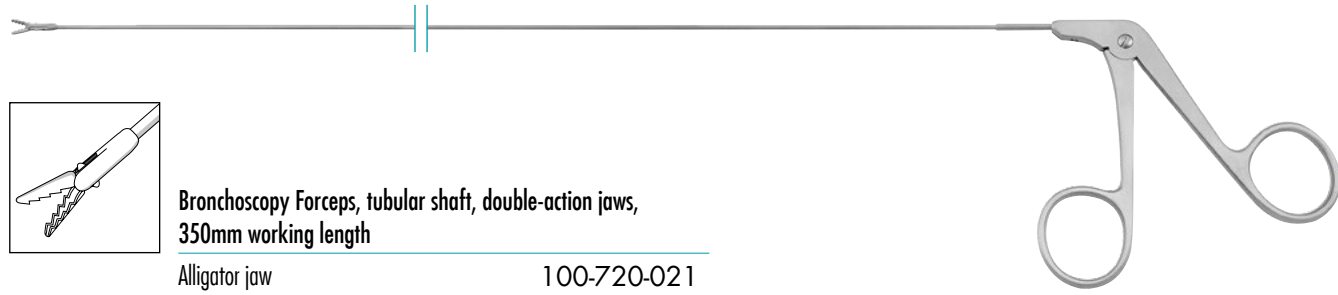

Bronchoscopy Forceps, tubular shaft, double-action jaws, 350mm working length
Alligator jaw 100-720-021

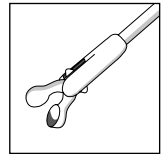
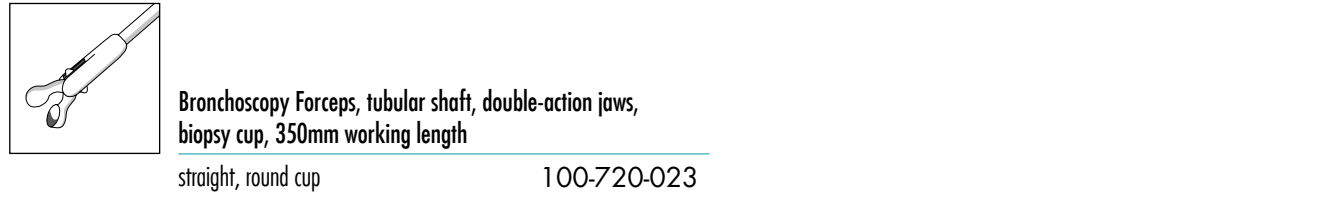

Bronchoscopy Forceps, tubular shaft, double-action jaws, biopsy cup, 350mm working length
straight, round cup 100-720-023



Bronchoscope, rigid, 540mm working length, 30°
Ø 5.5mm 100-655-100

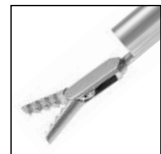
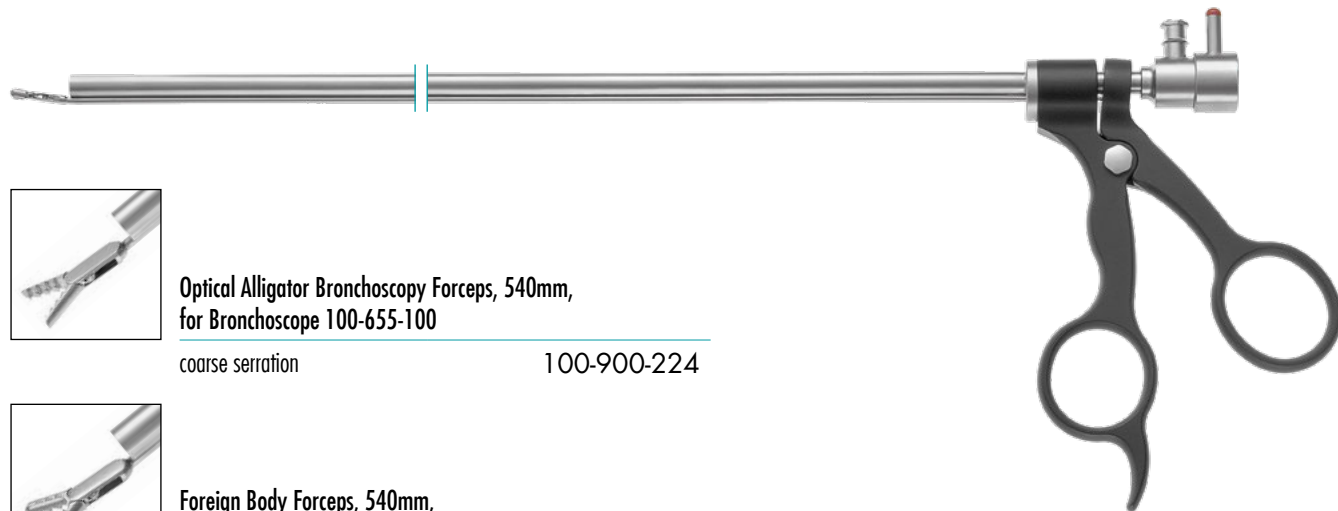

Optical Alligator Bronchoscopy Forceps, 540mm, for Bronchoscope 100-655-100
coarse serration 100-900-224

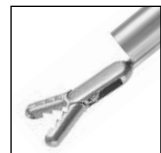
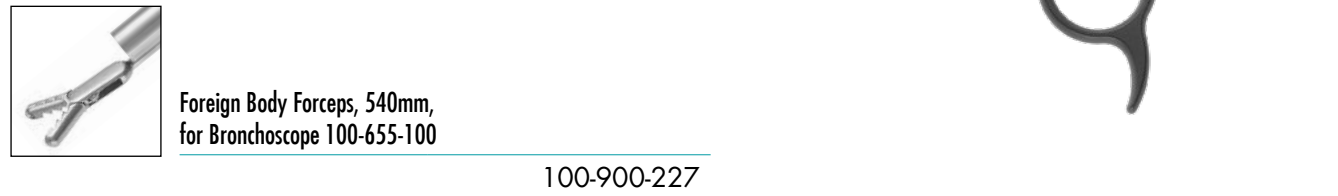

Foreign Body Forceps, 540mm, for Bronchoscope 100-655-100
100-900-227



Bronchoscope, rigid, 300mm working length, 0°
Ø 2.9mm 100-629-000

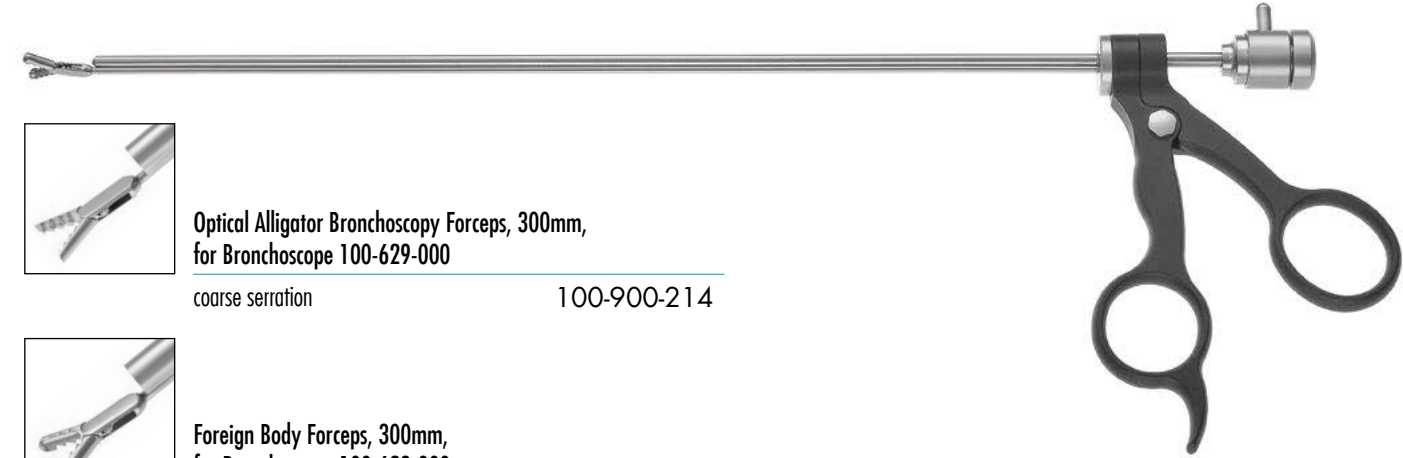

Optical Alligator Bronchoscopy Forceps, 300mm, for Bronchoscope 100-629-000
coarse serration 100-900-214

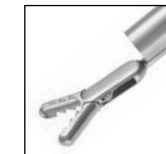

Foreign Body Forceps, 300mm, for Bronchoscope 100-629-000
100-900-217



Suction Tube, 250mm working length
Ø 2.5mm 100-860-025



Suction Tube, with flexible rubber tip
350mm 100-852-350
500mm 100-852-500

360° rotatable, color-coded instruments, 5 Charr.

- 360° rotatable, just with your finger tip
- Corrosion resistance due to lotus effect
- Self-holding grasping forceps



600mm working length,
flexible

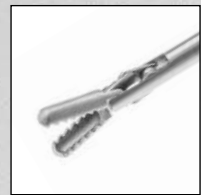

Stone Grasping Forceps,
double action jaw

■ knob color 253-951-005



Stone Grasping Forceps,
large stones, double action jaw

■ knob color 253-953-005



Hamada Long Stone Grasping
Forceps, double action jaw

■ knob color 253-955-005



Biopsy Forceps,
double action jaw

■ knob color 253-957-005



Scissors, single action jaw

■ knob color 253-959-005



340mm working length,
semi-flexible



Grasping Forceps, with cup,
serrated, double action jaw

■ knob color 351-116-335



Biopsy Forceps,
double action

■ knob color 351-120-335



Tenaculum Forceps, 1x1 teeth,
double action jaw

■ knob color 351-117-335

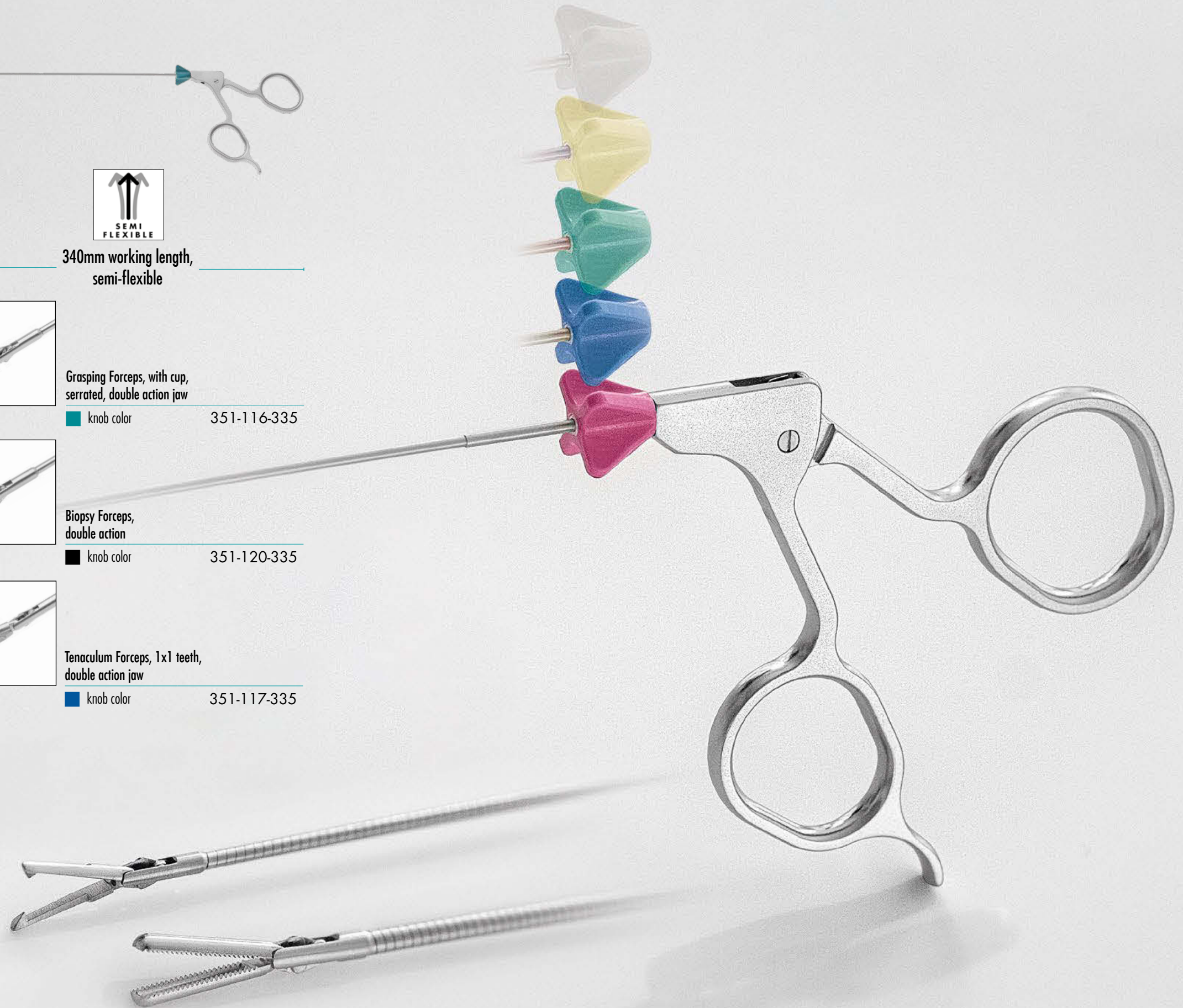

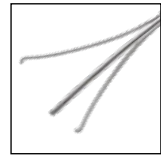
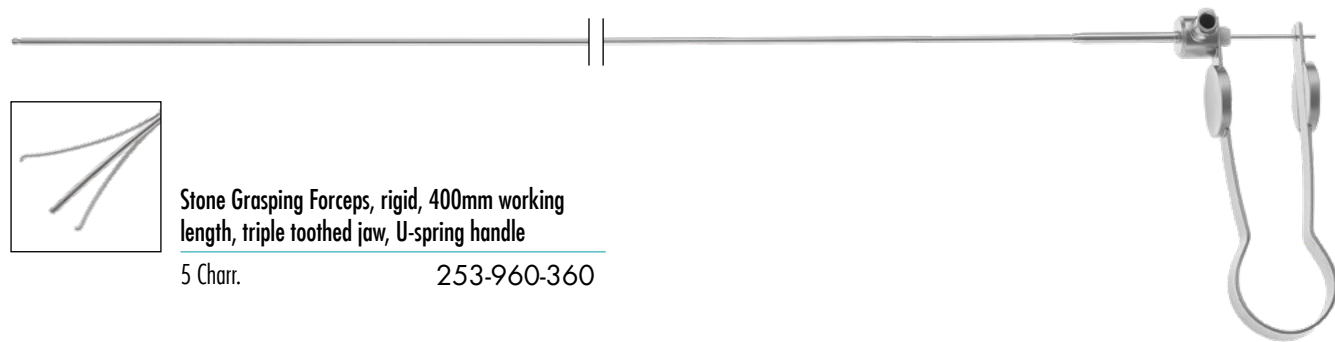

Stone Grasping Forceps, rigid, 400mm working length, triple toothed jaw, U-spring handle

5 Charr. 253-960-360

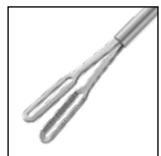
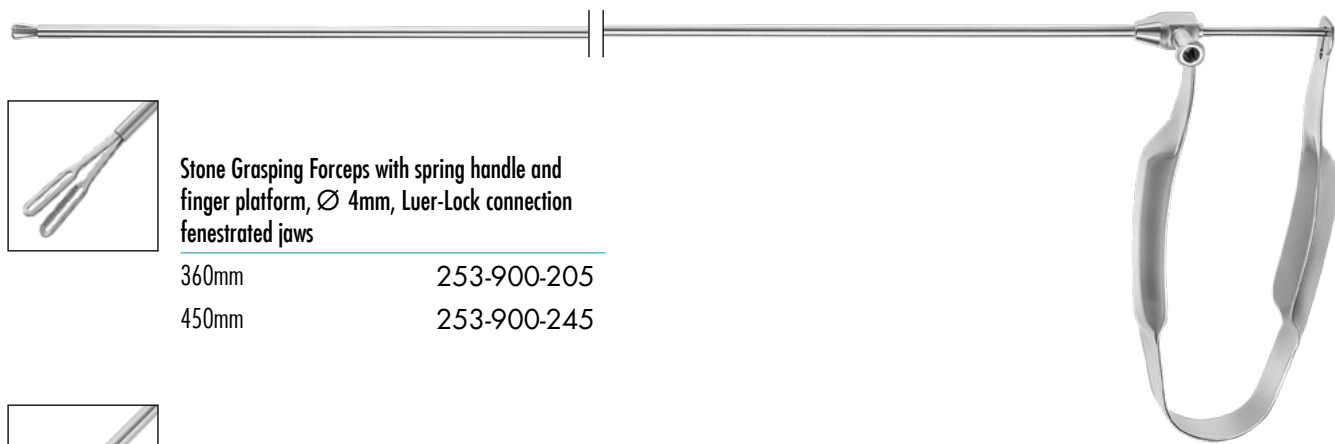

Stone Grasping Forceps with spring handle and finger platform, Ø 4mm, Luer-Lock connection fenestrated jaws

360mm 253-900-205
450mm 253-900-245



Stone Grasping Forceps with spring handle and finger platform, Ø 4mm, Luer-Lock connection, 3 prongs

360mm 253-900-206
450mm 253-900-246

Accessories for flexible endoscopes

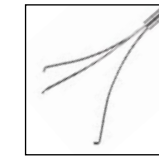

3 prongs Grasper, 600mm working length

Ø 1.8mm, 600mm working length 253-940-005



FLEXIBLE

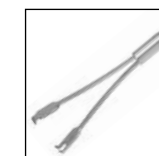

Foregin Body Retriever, 2x2 teeth

Ø 1.8mm, 2300mm working length 310-970-230
Ø 2.3mm, 1800mm working length 310-971-230
Ø 2.3mm, 1200mm working length 310-971-120

2x1 teeth

Ø 2.3mm, 2300mm working length 310-973-230
Ø 1.8mm, 1800mm working length 310-972-180

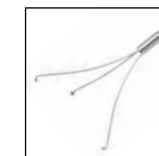

3 prongs Retriever, round

Ø 1.8mm, 1800mm working length 310-981-180
Ø 1.8mm, 2300mm working length 310-981-230
Ø 2.3mm, 1800mm working length 310-982-180
Ø 2.3mm, 2300mm working length 310-982-230



4 prongs Retriever, sharp

Ø 2.3mm, 2300 mm working length 310-983-230





Long Oval Cup, serrated

∅ 1.8mm, 1200mm WL	310-935-120
∅ 1.8mm, 1800mm WL	310-935-180
∅ 2.3mm, 1200mm WL	310-937-120
∅ 2.3mm, 1600mm WL	310-937-160
∅ 2.3mm, 1800mm WL	310-937-180
∅ 2.3mm, 2300mm WL	310-937-230



Long Oval Cup, fenestrated

∅ 1.0mm, 1200mm WL	310-901-120
∅ 1.4mm, 1600mm WL	310-902-160
∅ 1.6mm, 1600mm WL	310-903-160
∅ 1.8mm, 1800mm WL	310-904-180
∅ 2.3mm, 2300mm WL	310-906-230



Long Oval Cup, fenestrated, with needle

∅ 1.8mm, 1200mm WL	310-907-120
∅ 1.8mm, 1600mm WL	310-907-160
∅ 2.1mm, 1600mm WL	310-908-160
∅ 2.3mm, 2300mm WL	310-909-230



Biopsy Forceps, oval cup with fine teeth

∅ 1.8mm, 1200mm WL	310-944-120
∅ 1.8mm, 1800mm WL	310-944-180
∅ 2.3mm, 1600mm WL	310-945-160
∅ 2.3mm, 2300mm WL	310-945-230



Round Cup, fenestrated

∅ 2.3mm, 1800mm WL	310-930-180
∅ 2.9mm, 1200mm WL	310-930-120
∅ 3.4mm, 2300mm WL	310-931-230



Alligator Forceps

∅ 1.0mm, 1200mm WL	310-960-120
∅ 1.4mm, 1600mm WL	310-961-160
∅ 1.6mm, 1600mm WL	310-962-160
∅ 1.6mm, 1800mm WL	310-962-180
∅ 1.8mm, 1800mm WL	310-963-180
∅ 1.8mm, 2300mm WL	310-963-230
∅ 2.3mm, 1800mm WL	310-964-180
∅ 2.3mm, 2300mm WL	310-964-230
∅ 3.0mm, 2300mm WL	310-965-230



Rat Tooth, 2x1 teeth

∅ 1.8mm, 1200mm WL	310-952-120
∅ 1.8mm, 1800mm WL	310-952-180
∅ 2.3mm, 1600mm WL	310-953-160
∅ 2.3mm, 2300mm WL	310-953-230
∅ 3.0mm, 2300mm WL	310-954-230

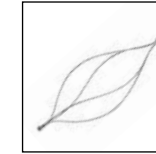

Dormia Metal Stone Basket

7 Charr., 1800mm WL	253-585-187
7 Charr., 2300mm WL	253-585-237
5 Charr., 1800mm WL	253-585-185
5 Charr., 2300mm WL	253-585-235
5 Charr., 600mm WL	253-585-005

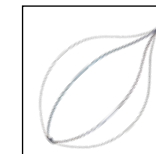

Stone Basket, tipless, ball shape, nitinol, ∅ 12mm, sterile/single use, 1200mm working length

1.3 Charr.	253-960-013
1.9 Charr.	253-960-019

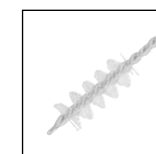

Brush for Cystology, 3.0 Charr., single use, package of 5 pieces

3.0 Charr.	253-962-003
------------	-------------

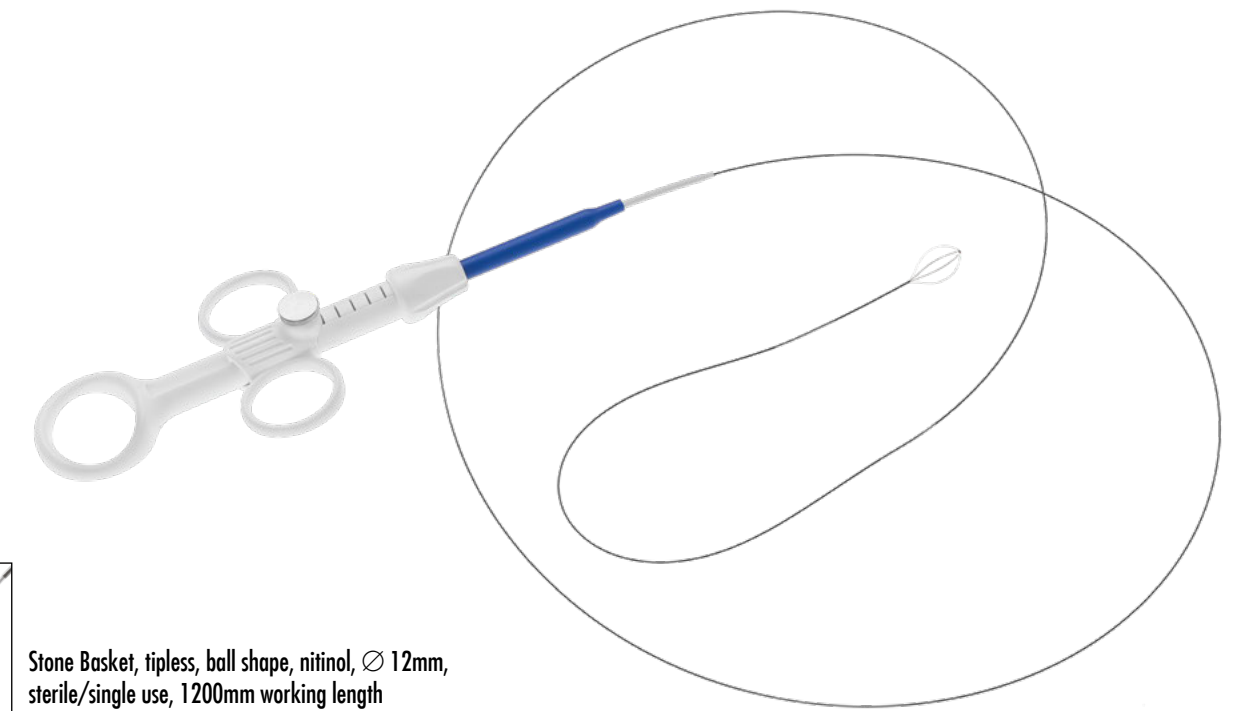

WL=working length
Forceps with other diameter and length are available on request

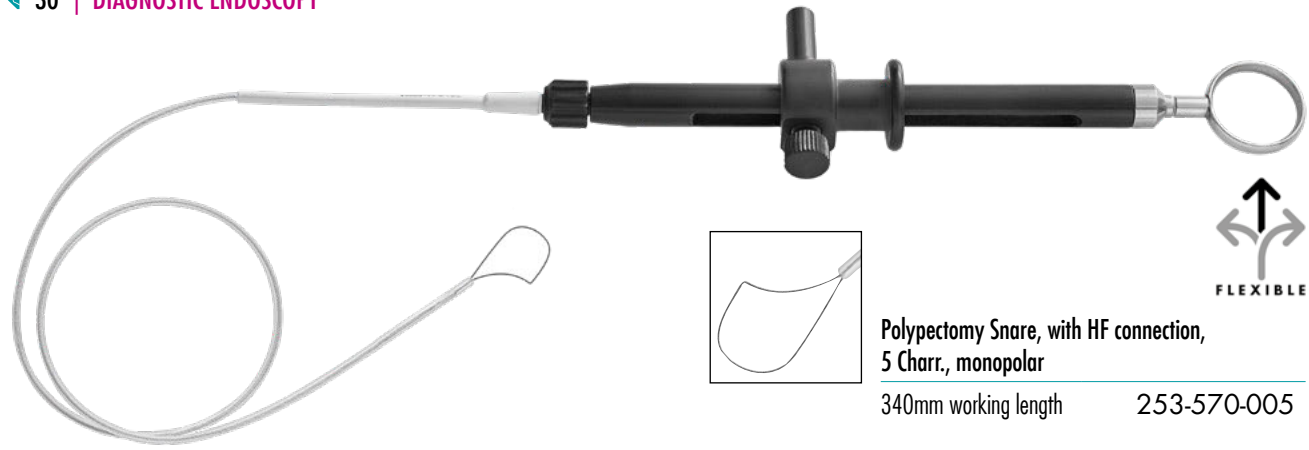

Polypectomy Snare, with HF connection,
5 Charr., monopolar
340mm working length 253-570-005

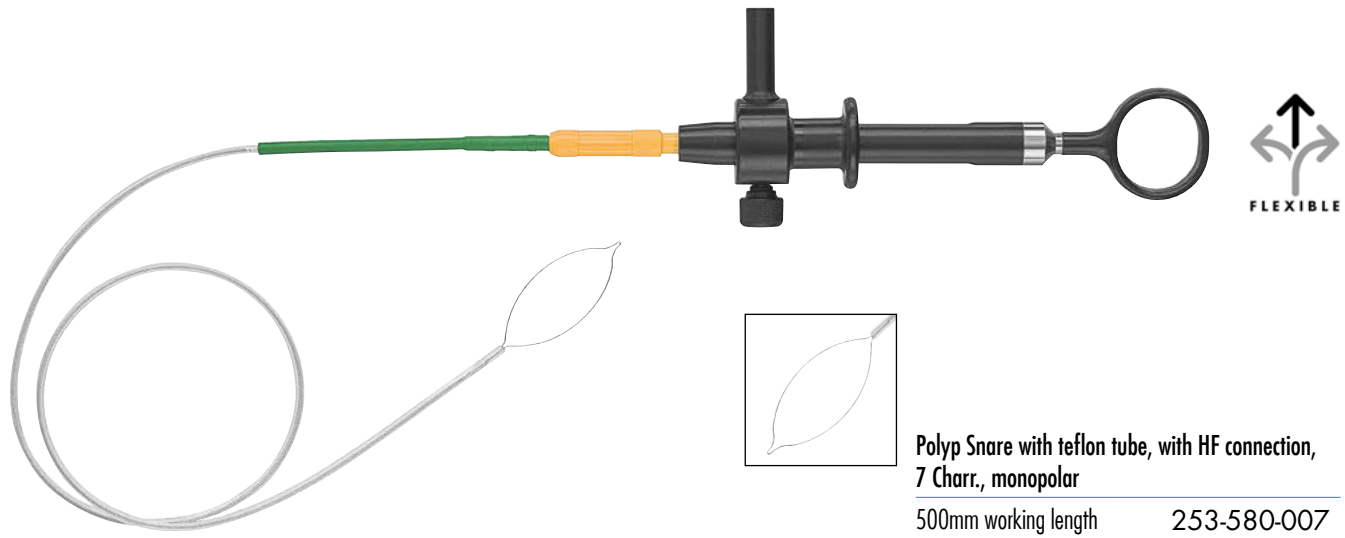

Polyp Snare with teflon tube, with HF connection,
7 Charr., monopolar
500mm working length 253-580-007

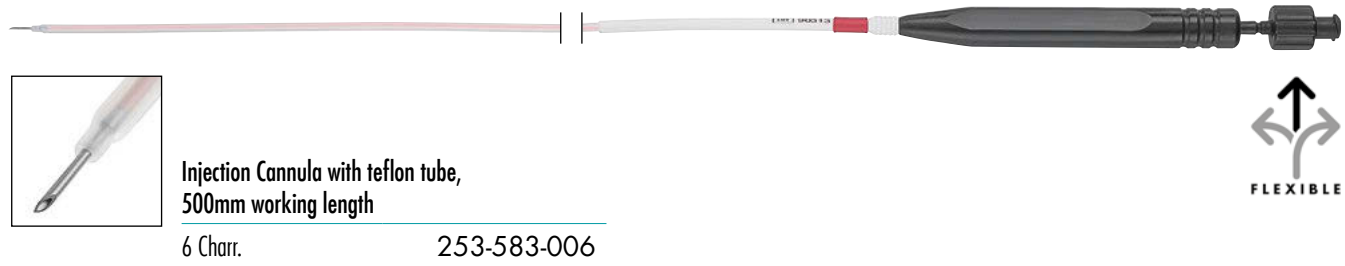

Injection Cannula with teflon tube,
500mm working length
6 Charr. 253-583-006

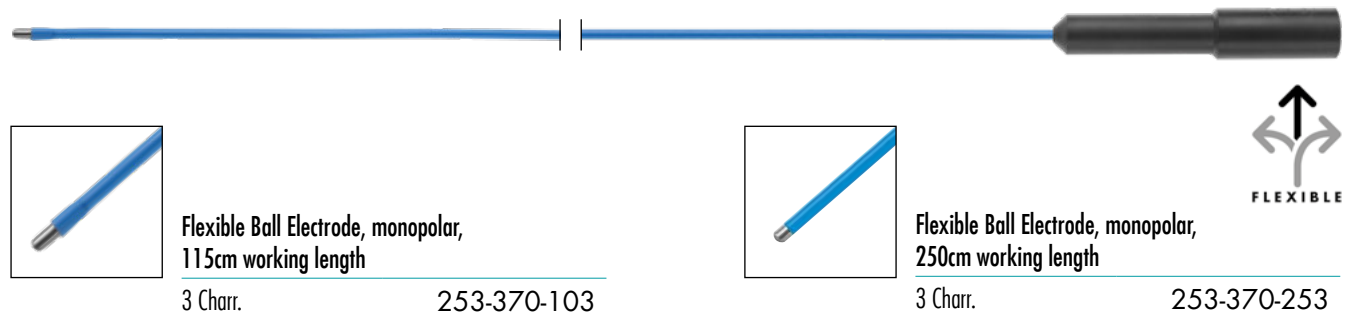

Flexible Ball Electrode, monopolar,
115cm working length
3 Charr. 253-370-103

Flexible Ball Electrode, monopolar,
250cm working length
3 Charr. 253-370-253

Urology/Vaginoscopy
Hysteroscopy



SMALL
Ø2.0mm

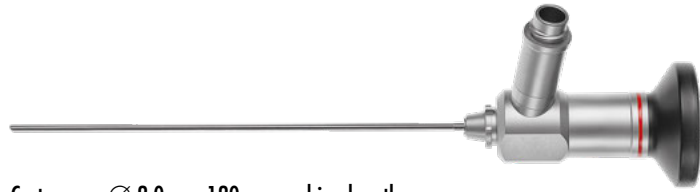

Cystoscope, Ø 2.0mm, 120mm working length

0°	253-221-000
30°	253-221-030

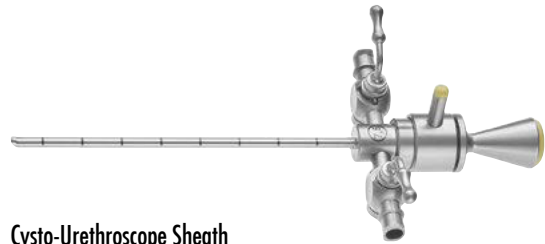

Cysto-Urethroscope Sheath

7.5 Charr.	253-200-007
------------	-------------

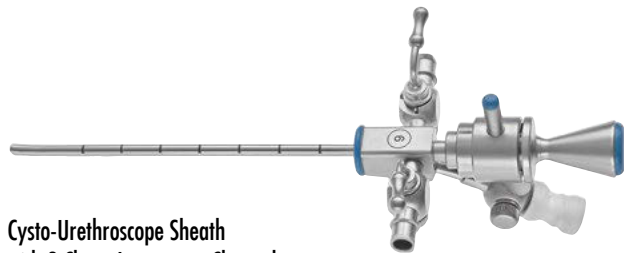

Cysto-Urethroscope Sheath with 3 Charr. Instrument Channel

9 Charr.	253-200-007
----------	-------------



LARGE
Ø2.7mm



Cystoscope, Ø 2.7mm, 187mm working length

0°	253-227-000
30°	253-227-030

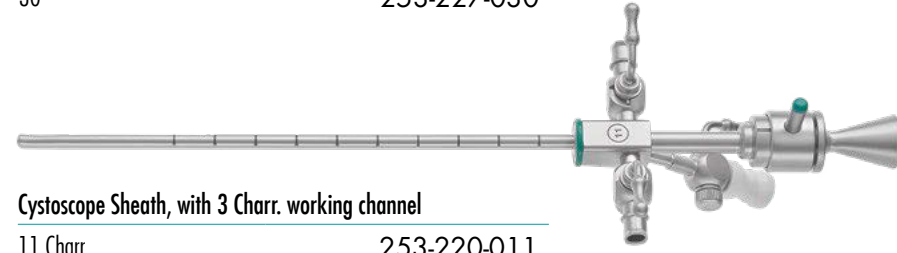

Cystoscope Sheath, with 3 Charr. working channel

11 Charr.	253-220-011
-----------	-------------

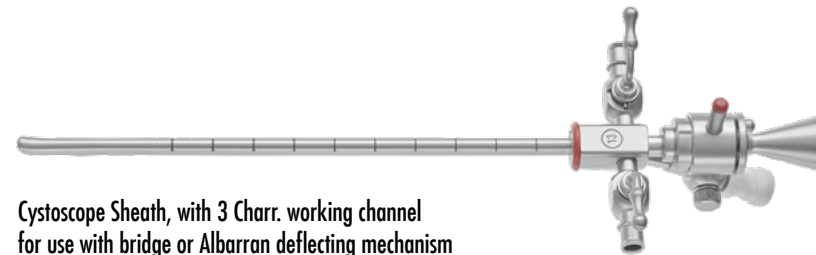

Cystoscope Sheath, with 3 Charr. working channel for use with bridge or Albarran deflecting mechanism

13 Charr.	253-220-014
-----------	-------------

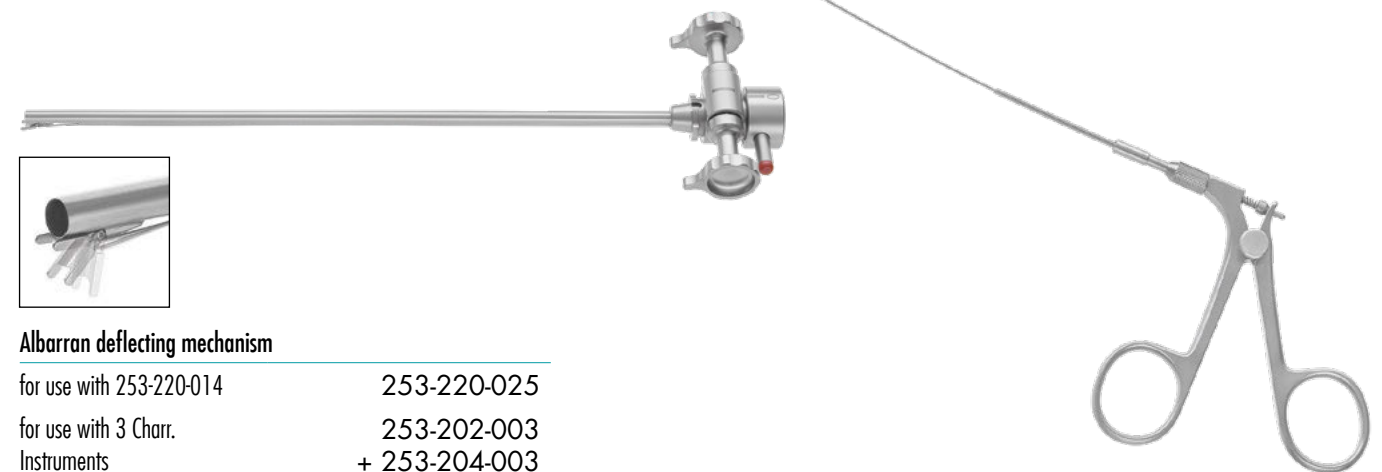
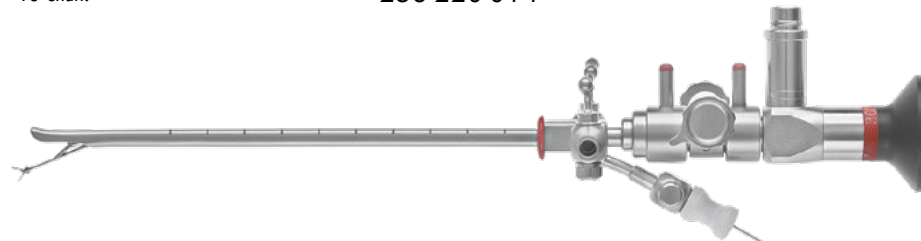

Albarran deflecting mechanism

for use with 253-220-014	253-220-025
for use with 3 Charr. Instruments	253-202-003 + 253-204-003

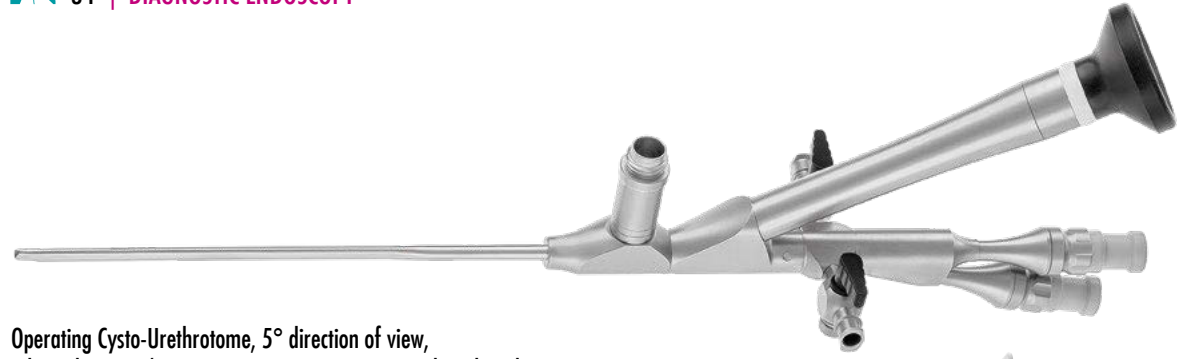

**Operating Cysto-Urethrotome, 5° direction of view,
2 lateral suction/irrigation connections, 140mm working length**

6.0 Charr. / 5.0 Charr. working channel 253-200-600
4.5 Charr. / 3.5 Charr. working channel 253-200-500



Silicone Valve
pack of 5 pcs. 253-905-400



Sinuscope, Ø 2.7mm, 180mm working length
30° 252-127-030

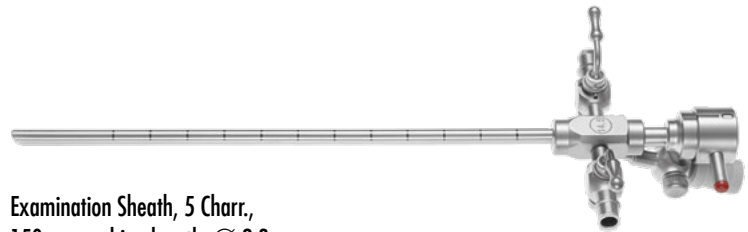

**Examination Sheath, 5 Charr.,
150mm working length, Ø 2.8mm**
for 30° telescope 252-027-185

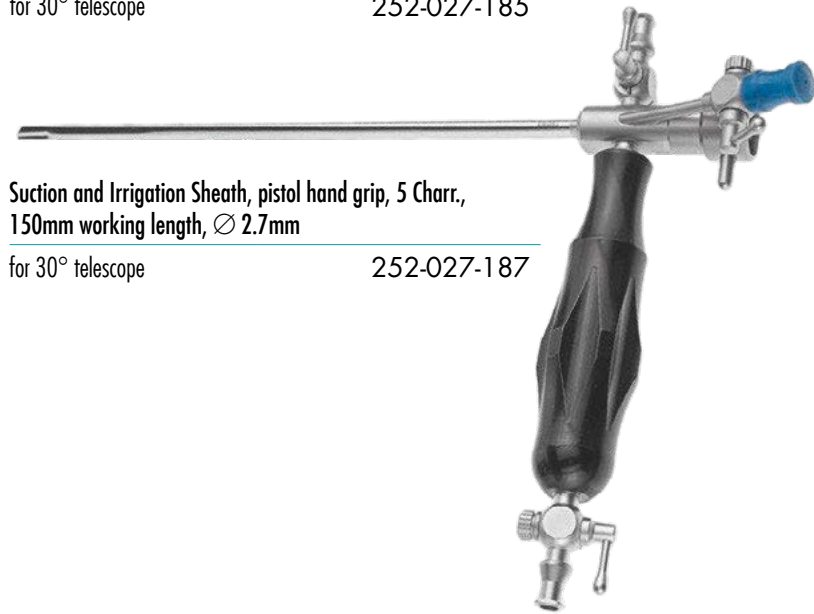

**Suction and Irrigation Sheath, pistol hand grip, 5 Charr.,
150mm working length, Ø 2.7mm**
for 30° telescope 252-027-187



Ball Electrode, monopolar, 530mm length
5 Charr. 253-370-005

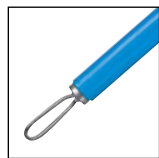

Loop Electrode, monopolar, 530mm length
5 Charr. 253-372-005



Killian Specula, 145mm
36 x 7mm 420-145-036
75 x 7mm 420-145-075



Cottle Specula with set-screw, 135mm
38mm 420-136-035
70mm 420-136-070



St. Clair Thompson Specula, 73mm
38mm 420-052-001
65mm 420-002-003

Artificial Insemination



Advanced Semi-Rigid Uretero-Renoscope
425mm working length 253-905-540

Distal tip	7.0 Charr.
Distal	8.0 Charr.
Proximal	9.5 Charr.
Working channel <small>(for use with instruments up to 5 Charr.)</small>	5.8 Charr.
Field of view	65°
Direction of View	5°

slim LINE



Advanced Semi-Rigid Uretero-Renoscope
425mm working length 253-910-540

Distal tip	6.0 Charr.
Distal	7.0 Charr.
Proximal	7.5 Charr.
Working channel <small>(for use with instruments up to 5 Charr.)</small>	5.0 Charr.
Field of view	65°
Direction of View	5°

superslim LINE



Advanced Semi-Rigid Uretero-Renoscope
425mm working length 253-915-540

Distal tip	4.5 Charr.
Distal	5.0 Charr.
Proximal	6.0 Charr.
Working channel <small>(for use with instruments up to 5 Charr.)</small>	4.0 Charr.
Field of view	65°
Direction of View	5°

Transurethral injection



Cystoscope, Ø 4.0mm, 300mm working length
12° 253-804-012



Passive Titanium Working element
for 253-804-012 253-000-232

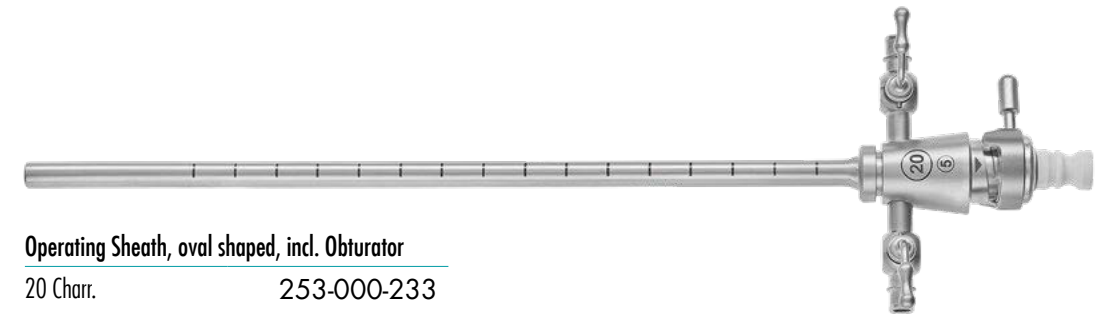

Operating Sheath, oval shaped, incl. Obturator
20 Charr. 253-000-233



Injection Cannula, semi-rigid, 2 Charr. distal end with rotatable Luer-Lock Adapter
4 Charr. 253-000-235

Exotic Animals

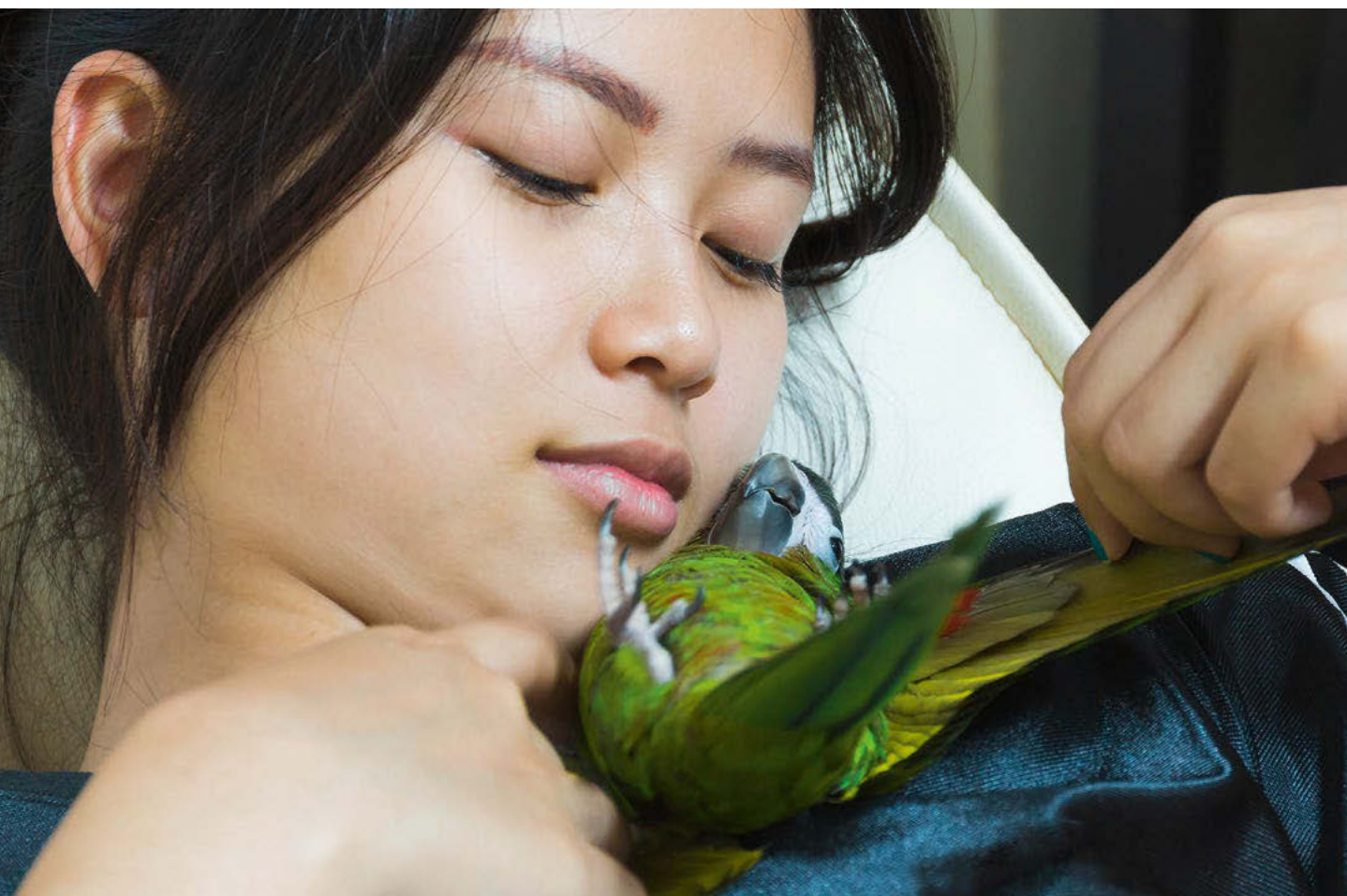

Mini Scope, \varnothing 1.7mm, 58mm working length
0° 225-017-000



Micro Sheath,
1 stopcock, \varnothing 2.3mm, 36mm working length
for 225-017-000 (0°) 225-217-036



LED Portable Lightsource, with 1700mAh charger
300-001-183



Mini Scope, \varnothing 2.0mm, 120mm working length
0° 253-221-000
30° 253-221-030

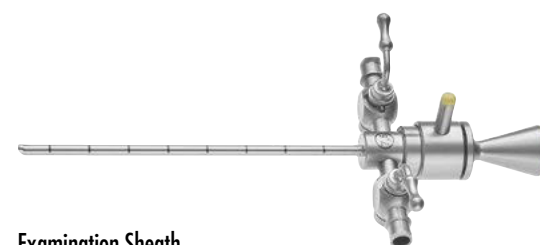

Examination Sheath
7.5 Charr. 253-200-007

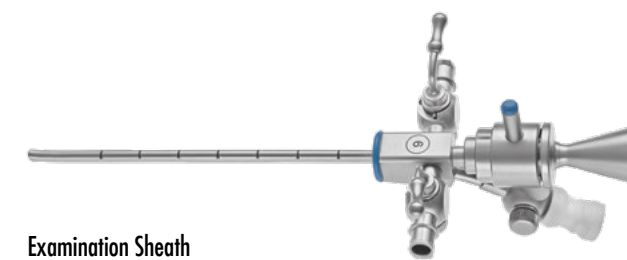

Examination Sheath
with 3 Charr. instrument channel
9 Charr. 253-200-009



Cystoscope, \varnothing 2.0mm, 187.5mm working length
0° 253-219-100
30° 253-219-130

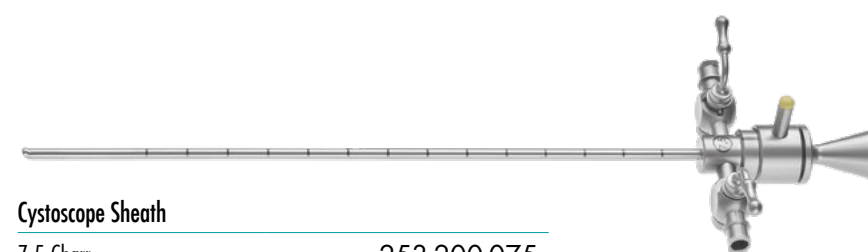

Cystoscope Sheath
7.5 Charr. 253-200-075

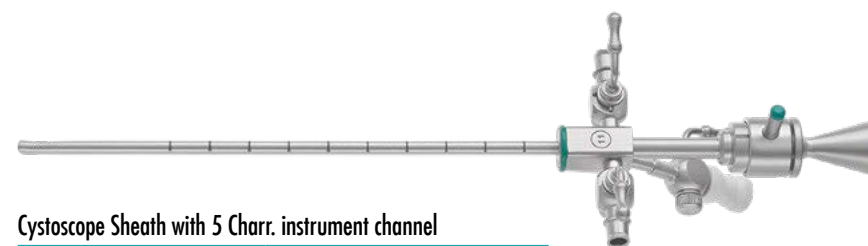

Cystoscope Sheath with 5 Charr. instrument channel
11 Charr. 253-200-011

arthroscopy.



ArthVIEW®

- Full HD scopes for your image
- Color code indicates direction of view
- High durable sapphire glass tip
- Optimized glass fiber arrangements for uniform brightness
- Fully autoclavable



ArthFLOW®

- The perfect match for your scopes
- 360° rotatable stopcocks
- Color coded
- Easy to clean and maintain
- Available in regular and high flow



Arthroscopy Set according to
Dr. med. vet. Scharvogel
Diplomate ECVS

225-999-001



Arthroscopy Set according to Dr. med. vet. Scharvogel

Diplomate ECVS

225-999-001

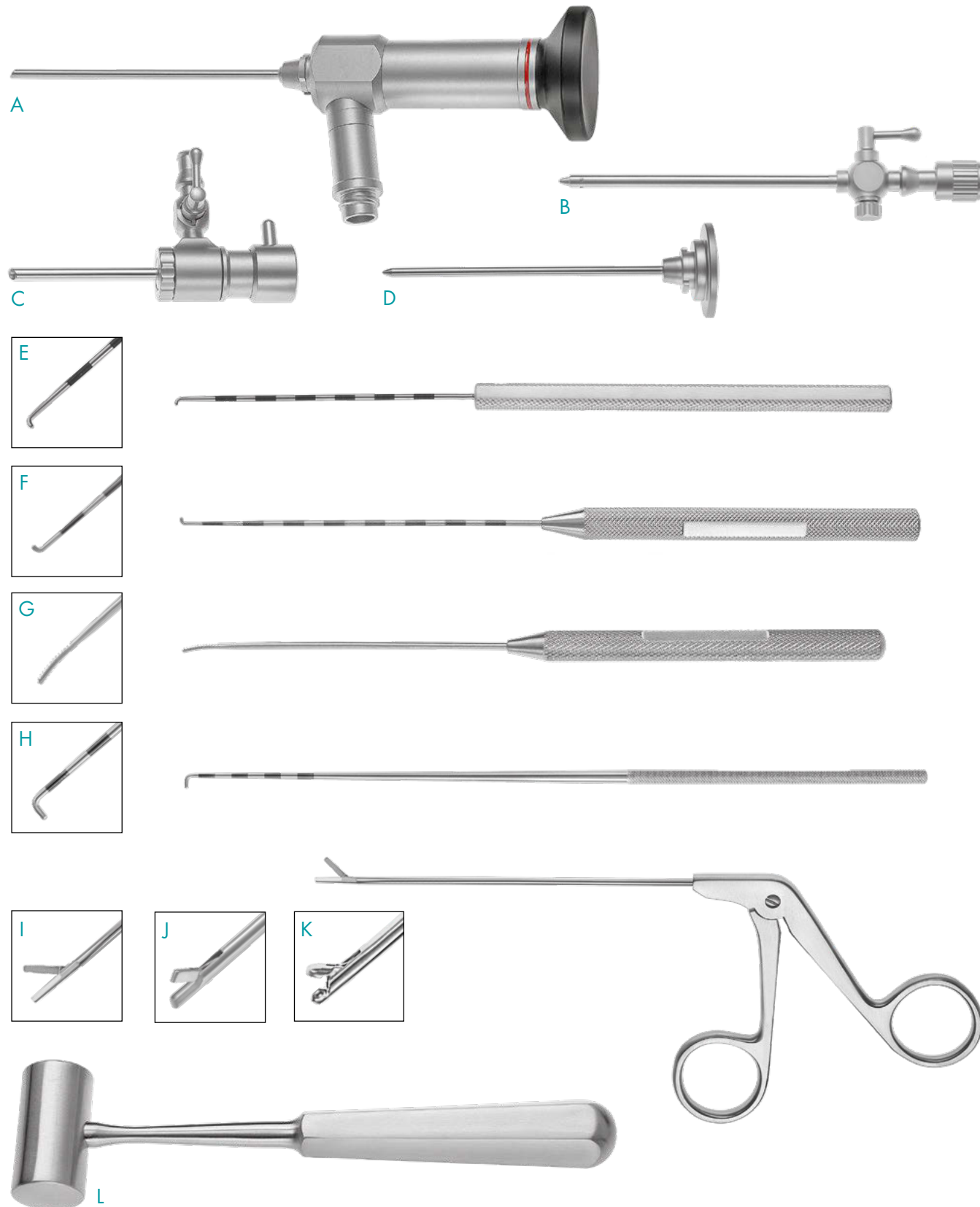

A	ArthView® Mini Arthroscope, \varnothing 2.4mm, 69mm working length	225-124-030
B	Irrigation Cannula Set incl. trocar and obturator, 70mm, \varnothing 2.3mm	225-850-000
C	ArthFlow® Sheath	225-512-332
D	ArthFlow® Obturator, for \varnothing 3.2mm operating sheath	225-512-532
E	Probe Hook, graduated, 75mm working length	225-100-115
F	Exploring Probe, 4mm, graduated	225-090-002
G	Mini Rasp, concave jaw, 90mm working length	225-090-004
H	Exploring Probe, 90° angled, Tip \varnothing 1.0 mm, graduated, 130mm working length	225-100-004
I	Mini Scissors, upwards cutting, \varnothing 2.0mm, 130mm working length	225-310-020
J	Mini Punch, \varnothing 2.0mm, 130mm working length	225-305-020
K	Mini Cupped Forceps, \varnothing 2.0mm, 130mm working length	225-307-020
L	Partsch Mallet, 120g, \varnothing 22mm	210-225-180
M	Hook Knife, 90° angled, 4mm, 130mm working length, black	225-100-038B
N	Walter Osteotome, 2mm, 190mm working length, black	420-580-002B
O	ArthVANCE® Alligator Grasping Forceps, 2.7mm straight jaw, slide lock handle, black	225-800-825B
P	ArthVANCE® Mini Grasping Forceps, straight jaws and shaft slide lock handle, 85mm working length, black	225-810-825B

Arthroscopy Set according to
Dr. med. vet. Scharvogel
 Diplomate ECVS

Devices recommendation



Q



R



S



T

Q	P1 Arthroscopy Pump	225-906-000V
R	Stunner S1 Shaver System	225-001-101V
S	F2 Digital Camera System	300-001-601V
T	LUMEN LED1 Light Source	300-900-180V



Blax Instruments

The next step to perfection. The Blax Instruments will give you a new experience of cutting sharpness and reliability.

- Higher corrosion resistance
- Sharpness retains longer
- Less light reflection
- High wear resistance



Hook Knife, 90° angled, 130mm working length
4mm 225-100-038B



Walter Osteotome, 190mm working length
2mm 420-580-002B



ArthVANCE® Alligator Grasping Forceps, slide lock handle
2.7mm straight jaw 225-800-825B



ArthVANCE® Mini Grasping Forceps, slide lock handle, 85mm working length
straight jaw /straight shaft 225-810-825B



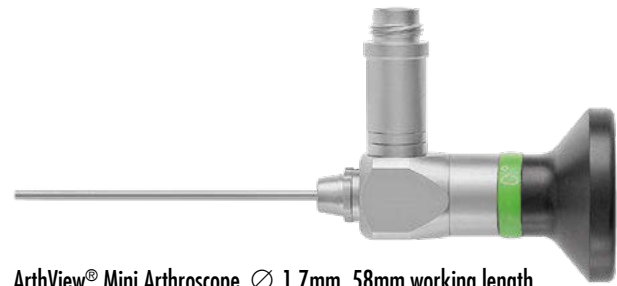

ArthView® Mini Arthroscope, Ø 1.7mm, 58mm working length
 0° 225-017-000
 15° 225-017-015



**ArthFlow® Mini Arthroscope Sheath
 1 stopcock, Ø 2.3mm, 36mm working length**
 for 225-017-000 (0°) 225-217-036



**ArthFlow® Mini Obturator / Trocar,
 for Ø 1.7mm operating sheath, 63mm working length**
 blunt 225-217-063
 sharp 225-217-065



**Mini
 Joints**
 Ø1.7mm

**Mini
 Joints**
 Ø1.9mm



ArthView® Mini Arthroscope, Ø 1.9mm, 69mm working length
 0° 225-019-000
 30° 225-019-030
102mm working length
 30° 225-019-030



**ArthFlow® Mini Obturator / Trocar,
 for Ø 2.5mm operating sheath, green color code
 69mm working length**
 blunt 225-511-525
 sharp 225-511-625
**for Ø 2.8mm operating sheath, blue color code
 102mm working length**
 blunt 225-510-528
 sharp 225-510-628

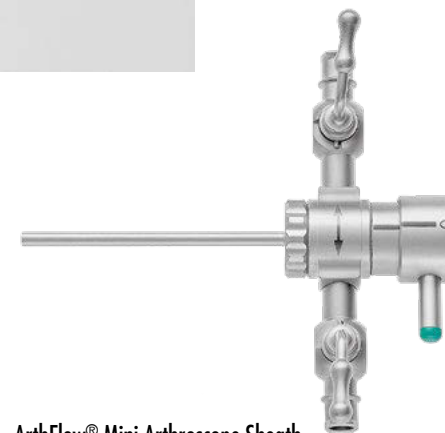

**ArthFlow® Mini Arthroscope Sheath
 2 stopcocks, Ø 2.5mm, green color code,
 69mm working length**
 for 225-019-030 (30°) 225-512-225
 for 225-019-000 (0°) 225-511-225
Ø 2.8mm, 102mm working length, blue color code
 for 225-019-130 (30°) 225-510-428

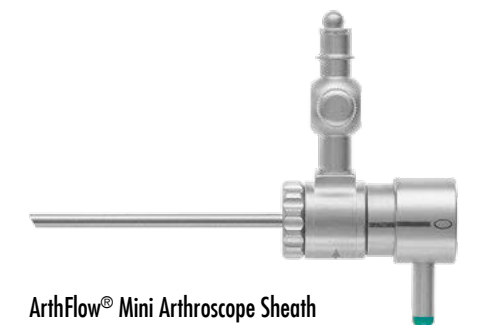

**ArthFlow® Mini Arthroscope Sheath
 1 stopcock, Ø 2.5mm, green color code**
 for 225-019-030 (30°) 225-512-125
 for 225-019-000 (0°) 225-511-125
Ø 2.8mm, 102mm working length, blue color code
 for 225-019-130 (30°) 225-510-328



Small Joints
Ø2.4mm

ArthView® Mini Arthroscope, Ø 2.4mm, 69mm working length	
30°	225-124-030
0°	225-124-000

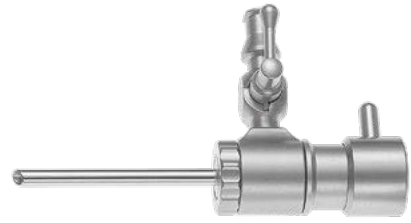

ArthFlow® Arthroscope Sheath, 1 stopcock, Ø 3.2mm	
for 225-124-030 (30°)	225-512-332
for 225-124-000 / universal	225-512-232



ArthFlow® Obturator / Trocar, for Ø 3.2mm operating sheath	
blunt, for 225-512-332	225-512-532
sharp, for 225-512-332	225-512-632

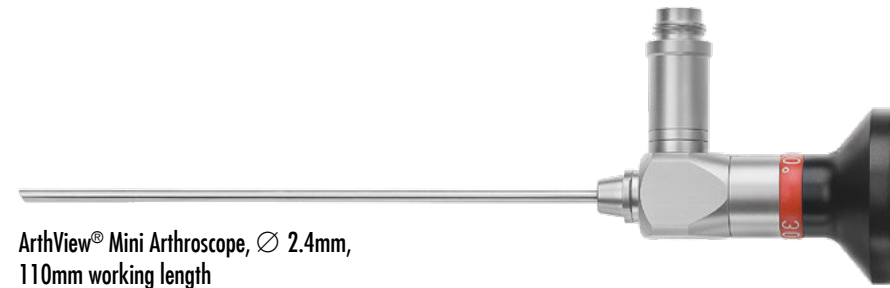

ArthView® Mini Arthroscope, Ø 2.4mm, 110mm working length	
30°	225-224-030
0°	225-224-000
70°	225-224-070

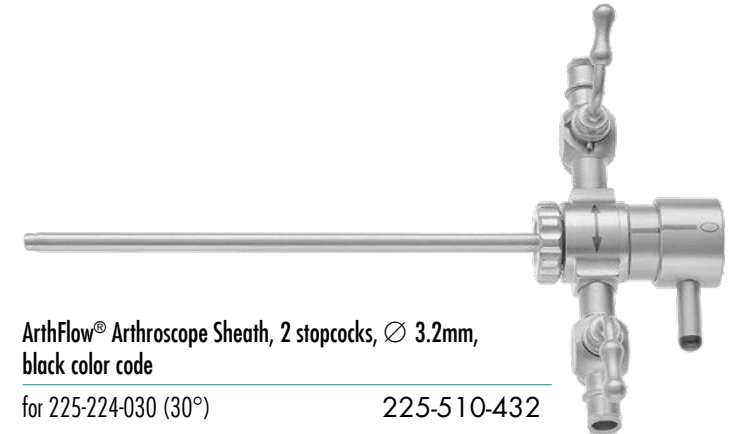

ArthFlow® Arthroscope Sheath, 2 stopcocks, Ø 3.2mm, black color code	
for 225-224-030 (30°)	225-510-432
for 225-224-000 (0° + 70°)	225-510-232

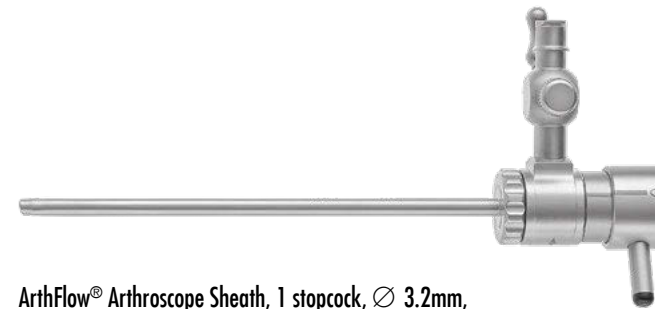

ArthFlow® Arthroscope Sheath, 1 stopcock, Ø 3.2mm, black color code	
for 225-224-030 (30°)	225-510-332
for 225-224-000 (0° + 70°)	225-510-132



ArthFlow® Mini Obturator / Trocar, for Ø 3.2mm operating sheath, black color code	
blunt	225-510-532
sharp	225-510-632

Small Joints
Ø2.7mm

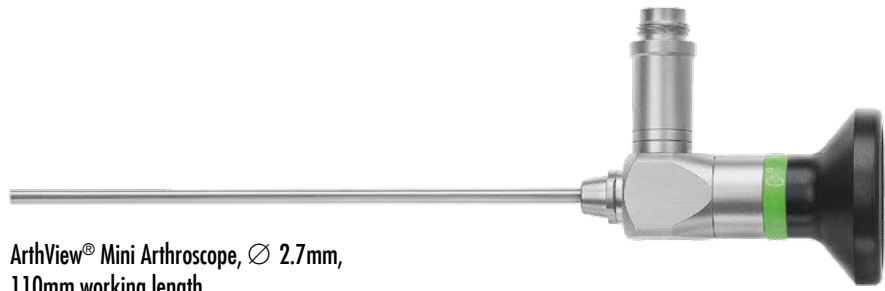

ArthView® Mini Arthroscope, Ø 2.7mm, 110mm working length

0°	225-227-000
30°	225-227-030
70°	225-227-070



ArthFlow® Mini Arthroscope Sheath 2 stopcocks, Ø 3.4mm, white color code

for 225-227-030 (30°)	225-500-434
for 225-227-000 (0° + 70°)	225-500-234

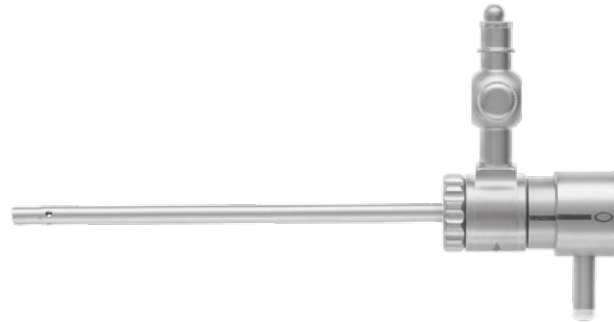

ArthFlow® Mini Arthroscope Sheath 1 stopcock, Ø 3.4mm, white color code

for 225-227-030 (30°)	225-500-334
for 225-227-000 (0° + 70°)	225-500-134



ArthFlow® Mini Obturator / Trocar, for Ø 3.4mm operating sheath, white color code

blunt	225-500-534
sharp	225-500-634



Large Joints
Ø4.0mm

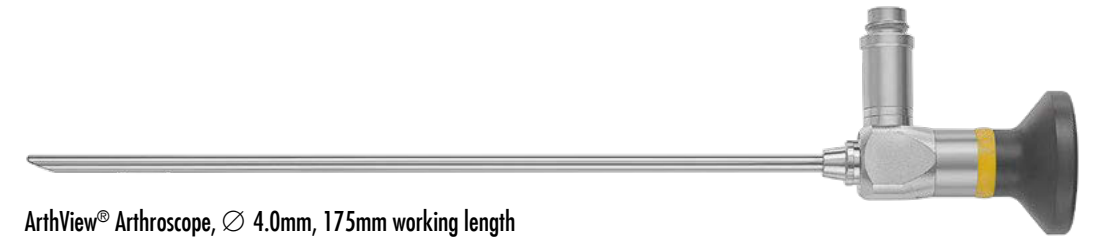

ArthView® Arthroscope, Ø 4.0mm, 175mm working length

0°	225-140-000
30°	225-140-030
45°	225-140-045
70°	225-140-070



ArthFlow® Arthroscope Sheath 2 stopcocks, Ø 5.5mm, blue color code

for 225-140-030, 30°	225-500-255
for 0°/30°/70°/45°/universal	225-500-355

Ø 6.0mm, red color code, high flow	
for 30°	225-500-260
for 0°/30°/70°/45°/universal	225-500-360



ArthFlow® Obturator / Trocar, for Ø 5.5mm operating sheath, blue color code

blunt	225-500-555
sharp	225-500-655

for Ø 6.0mm operating sheath, red color code	
blunt	225-500-560
sharp	225-500-660



ArthVANCE® Accessories

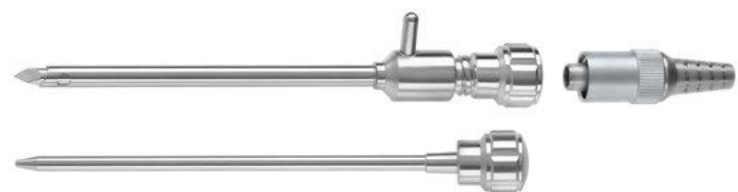

Inflow-Cannula, complete set with shaft, trocar with sharp tip, blunt obturator and irrigation adapter

∅ 4.5mm 225-850-145



Irrigation Cannula Set with 1 stopcock, including trocar and obturator, 70mm working length

∅ 2.3mm 225-850-000
∅ 3.5mm 225-850-001



Obturator, 70mm working length, blunt

∅ 2.3mm 225-850-002
∅ 3.5mm 225-850-004

Trocar, sharp

∅ 2.3mm 225-850-003
∅ 3.5mm 225-850-005

Operating Sheaths and Trocars

Cannula, 5.0mm 225-854-101
Cannula, 5.5mm 225-854-102
Cannula, 5.0mm, with valve 225-854-103
Cannula, 5.5mm, with valve 225-854-104
Trocar, sharp, 5.0mm 225-854-105
Trocar, sharp, 5.5mm 225-854-106



LuerLock tube connector
A 9.0mm 300-011-181
B 6.0mm 300-011-506



Sealing Cap, blue, package of 10 pcs.
∅ 5.5mm 300-023-905

Guiding and changing rods for use with trocar sheath

∅ 2.7mm x 230mm 225-865-027
∅ 3.5mm x 230mm 225-865-030
∅ 4.0mm x 230mm 225-865-040

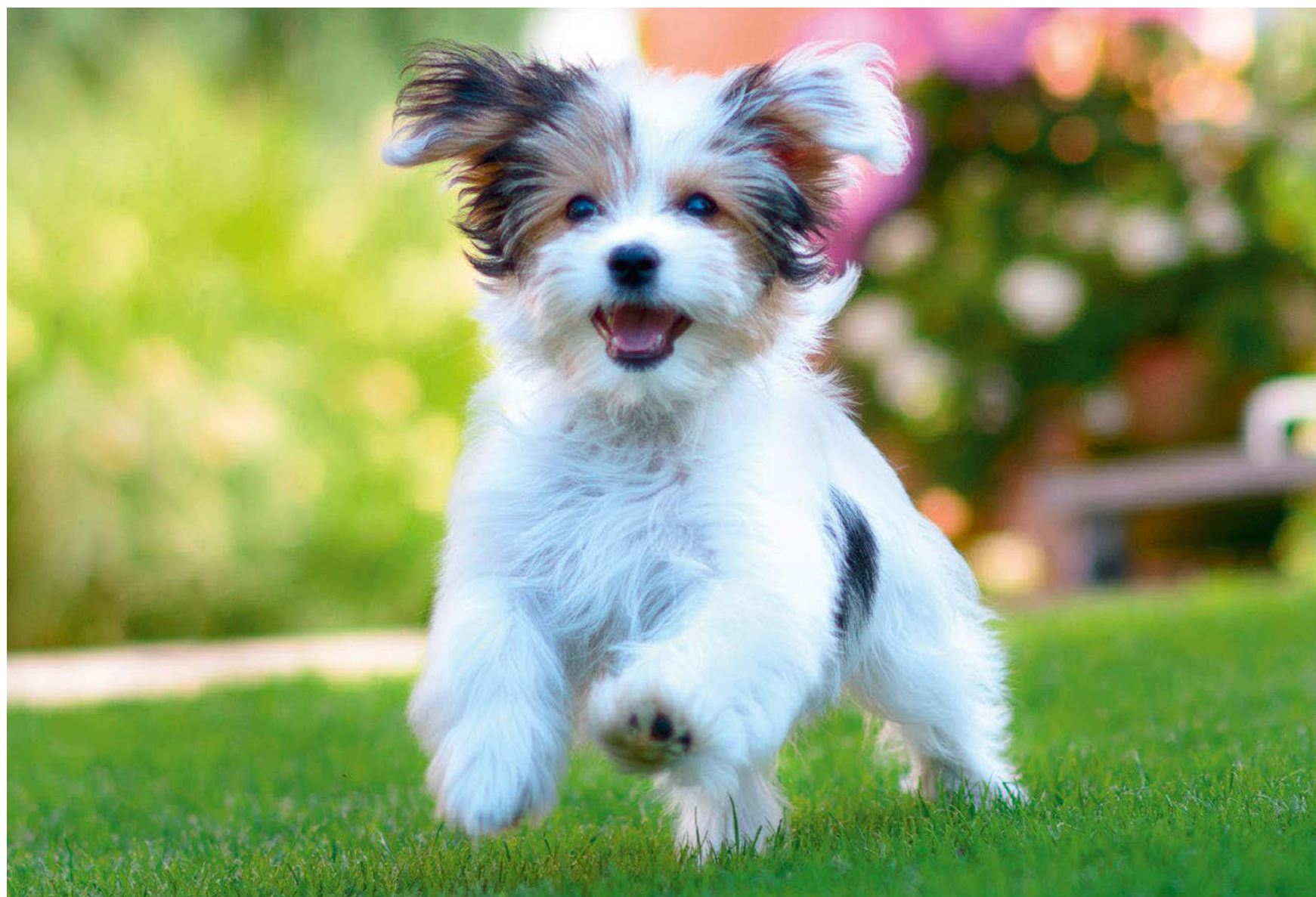

The logo for ArthVANCE, featuring a stylized blue and grey 'A' followed by the word 'ArthVANCE' in a grey sans-serif font with a registered trademark symbol.

Arthroscopic Instruments

Punches, Scissors and Grasping Forceps

The Arthvance Instruments provides for all joints and different anatomies the right pattern

- Low profile and small pinless jaw design allows access even to the smallest joint space
- Easy to clean with Luer-Lock connection
- Direct force transmission from your fingertip
- 100% Made in Germany

ArthVANCE® Mini Arthroscopic Instruments

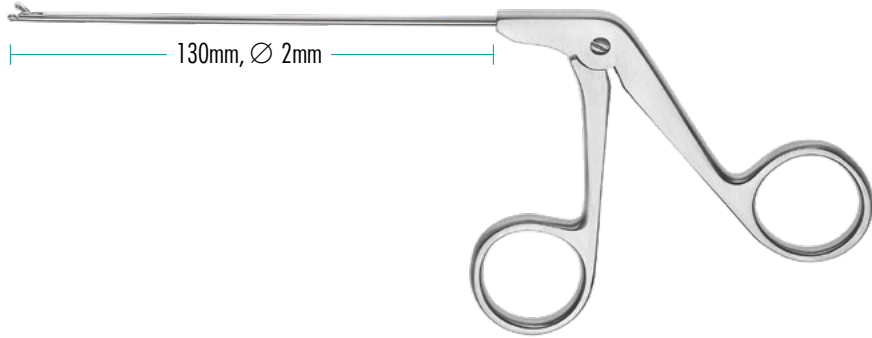

(Scale 1:1)

		Mini Punch	225-305-020
		Mini Scissors, downwards cutting	225-306-020
		Mini Cupped Forceps	225-307-020
		Mini Cupped Forceps, serrated cup	225-308-020
		Mini Grasping Forceps	225-309-020
		Mini Scissors, upwards cutting	225-310-020
		Short Mini Scissors, upwards cutting	225-311-020

Small Joints

Ø2.0mm

ArthVANCE® Arthroscopic Punches

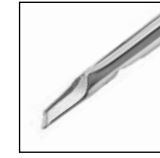
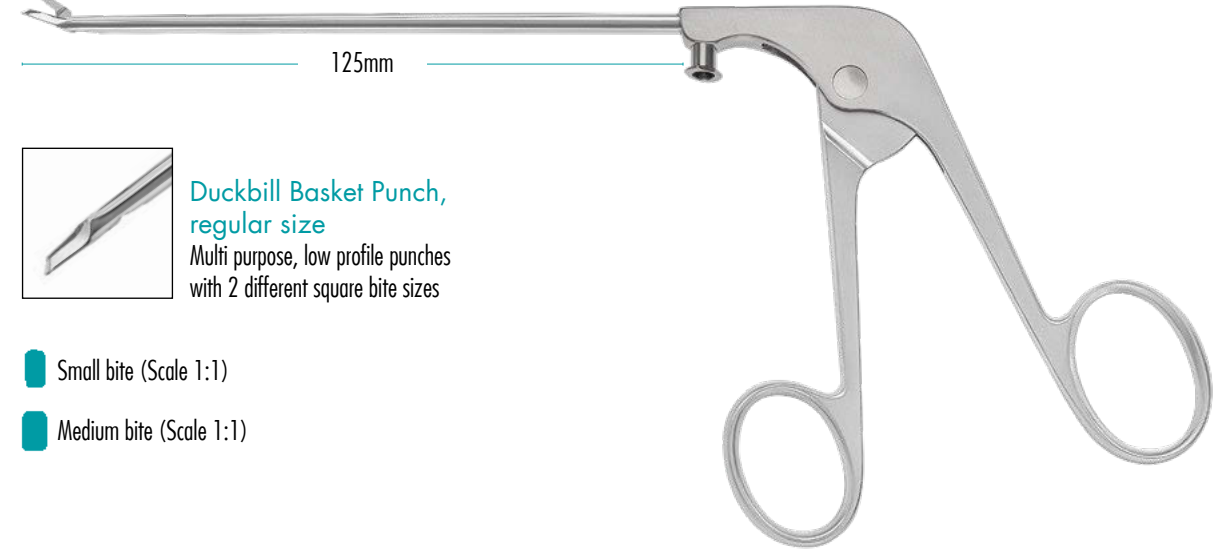

Duckbill Basket Punch, regular size
Multi purpose, low profile punches with 2 different square bite sizes

Small bite (Scale 1:1)

Medium bite (Scale 1:1)

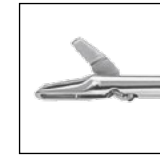

Duckbill Basket Punch, ring handle, straight shaft, straight jaw

small 225-800-101

medium 225-800-102

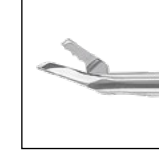

Rongeur, straight jaw, straight shaft, ring handle

small 225-800-104

left curved shaft, upbiter jaw

medium 225-800-107

right curved shaft, upbiter jaw

medium 225-800-109

Mini Punches

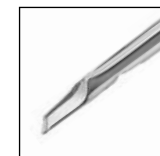
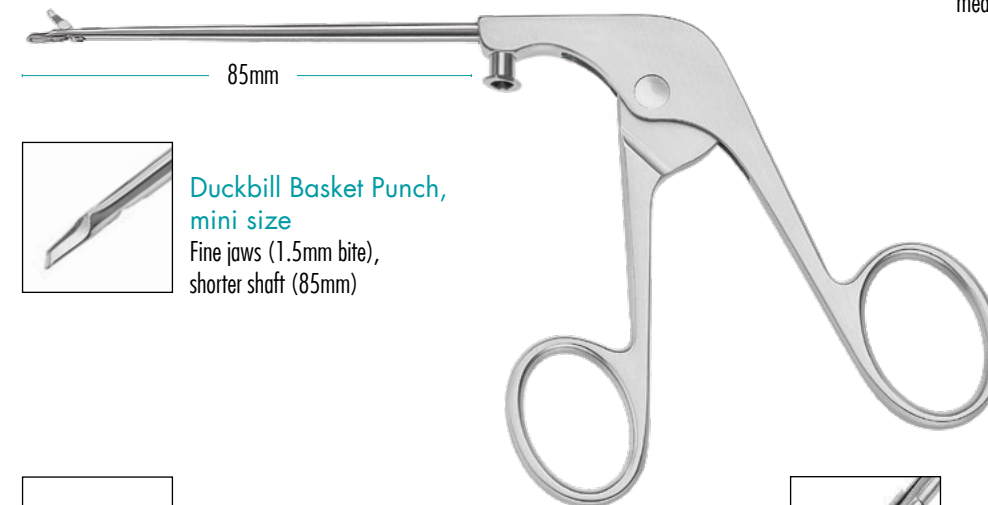

Duckbill Basket Punch, mini size
Fine jaws (1.5mm bite), shorter shaft (85mm)



Duckbill Mini Basket Punch, ring handle, straight shaft

straight jaw 225-810-102

upbiter jaw 225-810-105

straight jaw, left curved shaft 225-810-107

straight jaw, right curved shaft 225-810-109



Rongeur, straight jaw, straight shaft, ring handle

95mm working length 225-810-930

125mm working length 225-800-920

220mm working length 225-830-920

ArthVANCE® Arthroscopic Punches

Small bite (Scale 1:1)

Medium bite (Scale 1:1)



Duckling Basket Punch
Advanced Duckling low profile jaw, flat upper jaw moves completely into the lower jaw.



Duckling Elevator Basket Punch
With flat shovel for easy access.



Duckling Basket Punch, 125mm working length, straight shaft, ring handle

small	225-800-401
medium	225-800-402



Ring handle

medium	225-800-420
--------	-------------



Pro handle

medium	225-700-402
--------	-------------

Bite size (Scale 1:1)



Slimline Basket Punch
The narrow shaft and compact jaw design allows access and use in tight spaces such as the posterior aspect of the knee.



Ring handle, straight shaft, straight jaw, 125mm working length

small	225-800-002
-------	-------------



45° angled jaw

left	225-800-003
right	225-800-004

Bite size (Scale 1:1)



Backbiter
The Backbiter Basket Punch enables access to the anterior horn of the meniscus.

Ring handle, straight shaft, 125mm working length

left cutting	225-800-707
--------------	-------------

Bite size (Scale 1:1)



Oval Punch
Offers the lowest profile and the largest bite size for end-on as well as lateral cutting. The allrounder punch.

Ring handle, straight shaft, 125mm working length

straight jaw	225-800-202
--------------	-------------

Mini Oval Punch, 95mm working length

straight jaw	225-810-202
left jaws	225-810-203
right jaws	225-810-204



Blunt Nose
Enables a flush contouring of the meniscus

Ring handle, straight shaft, 85mm working length

straight jaw	225-810-302
--------------	-------------

Bite size (Scale 1:1)



Basket Punch SCOOP
Basket Punches are the traditional style instruments with a classical punch shape and the parrot peak upper jaw for a safe capture of tissue.

Ring handle, straight shaft, 125mm working length

1.0mm, straight jaw	225-800-802
1.3mm, angled jaw	225-800-805
1.3mm, downbiter jaw	225-800-806

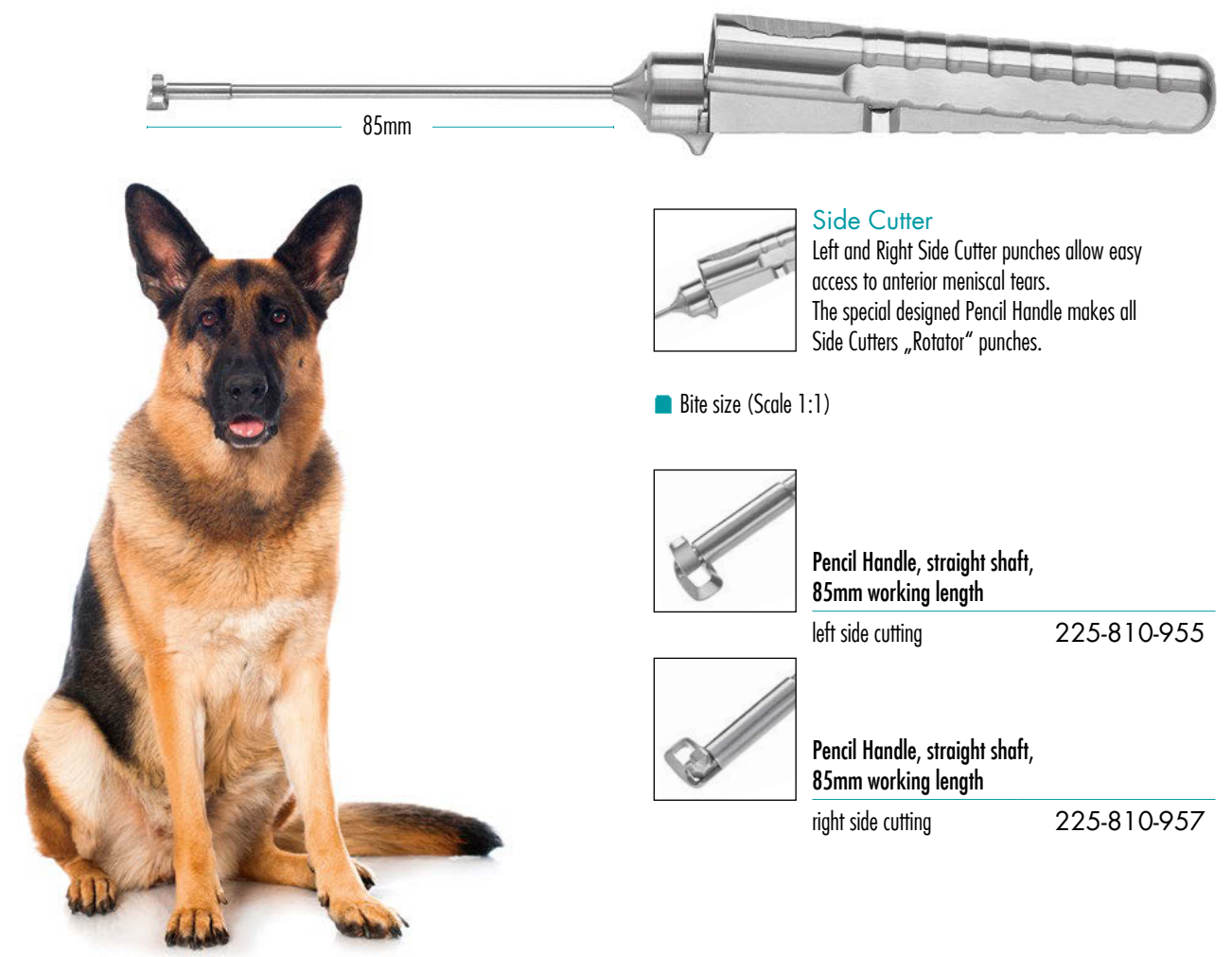
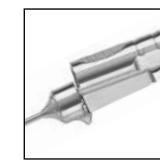
Side Cutter
Left and Right Side Cutter punches allow easy access to anterior meniscal tears. The special designed Pencil Handle makes all Side Cutters „Rotator“ punches.

Bite size (Scale 1:1)



Pencil Handle, straight shaft, 85mm working length

left side cutting	225-810-955
-------------------	-------------



Pencil Handle, straight shaft, 85mm working length

right side cutting	225-810-957
--------------------	-------------

ArthVANCE® Hook Scissors & Punches

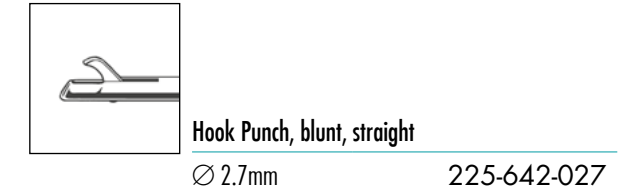
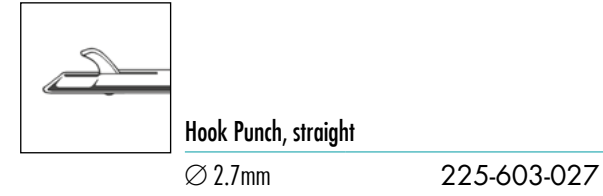
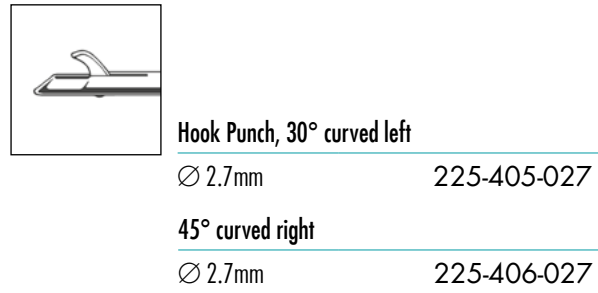
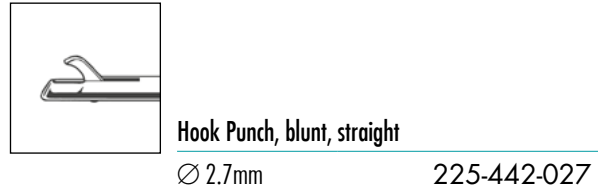

ArthVANCE® Grasping Forceps



Shark Grasper
With blunt 1x2 teeth and serrated inner jaws.



Alligator Grasper
Short jaw with multiple serrations



Shark Grasping Forceps, Pro Handle,
125mm working length, straight shaft
straight jaw 225-700-820

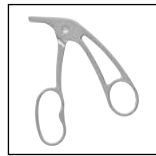

Alligator Grasping Forceps, Pro Handle,
125mm working length, straight shaft
2.7mm straight jaw 225-700-825



Slide Lock Handle, 125mm working length
straight jaw 225-800-820



Slide Lock Handle, 125mm working length
2.7mm straight jaw 225-800-825

Mini Shark, 85mm working length
straight jaw 225-810-820

Mini Alligator, 85mm working length
straight jaw 225-810-825



Cupped Grasper
Cupped jaw with atraumatic serrations.



Cupped Grasper, straight shaft,
125mm working length, 3.3mm straight jaw
Pro Handle 225-700-833



125mm working length, 2.7mm straight jaw
Slide Lock Handle 225-800-832

ArthVANCE® Scissors



Hook Scissors

Hook Scissors, straight jaw, Ring Handle,
125mm working length

straight shaft	225-800-472
15° left curved shaft	225-800-477
15° right curved shaft	225-800-479

Mini Hook Scissors, 2.7mm straight jaw,
85mm working length

straight shaft	225-810-472
----------------	-------------

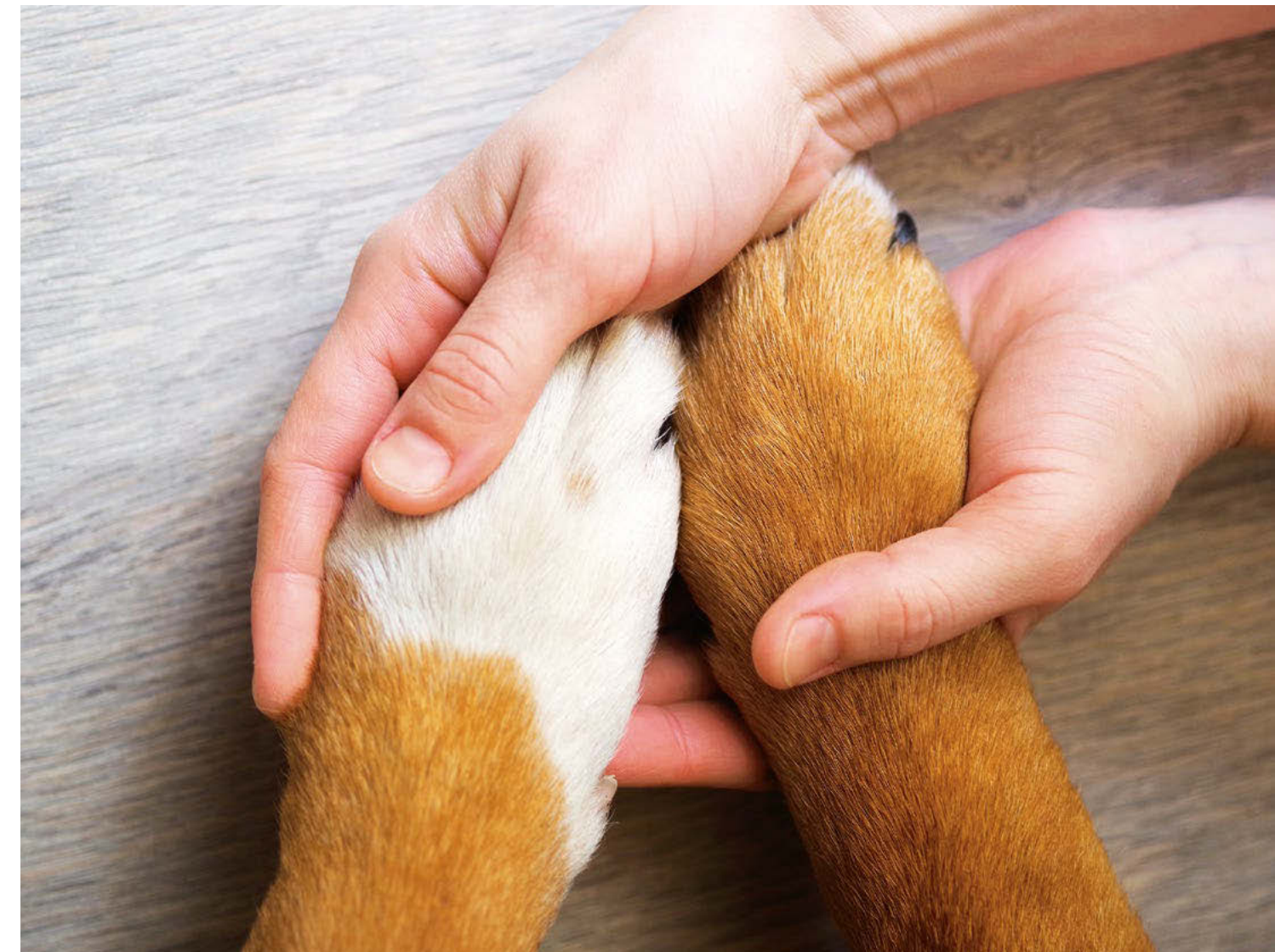

ArthVANCE® Suture Cutter



Suture Cutter
Suture Cutter with V-notch for pushing and cutting the knot.



Suture Cutter, v-notch, left opened, axial handle
155mm working length 225-820-100

ArthVANCE® Suction Punches

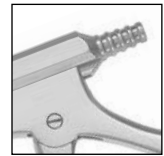
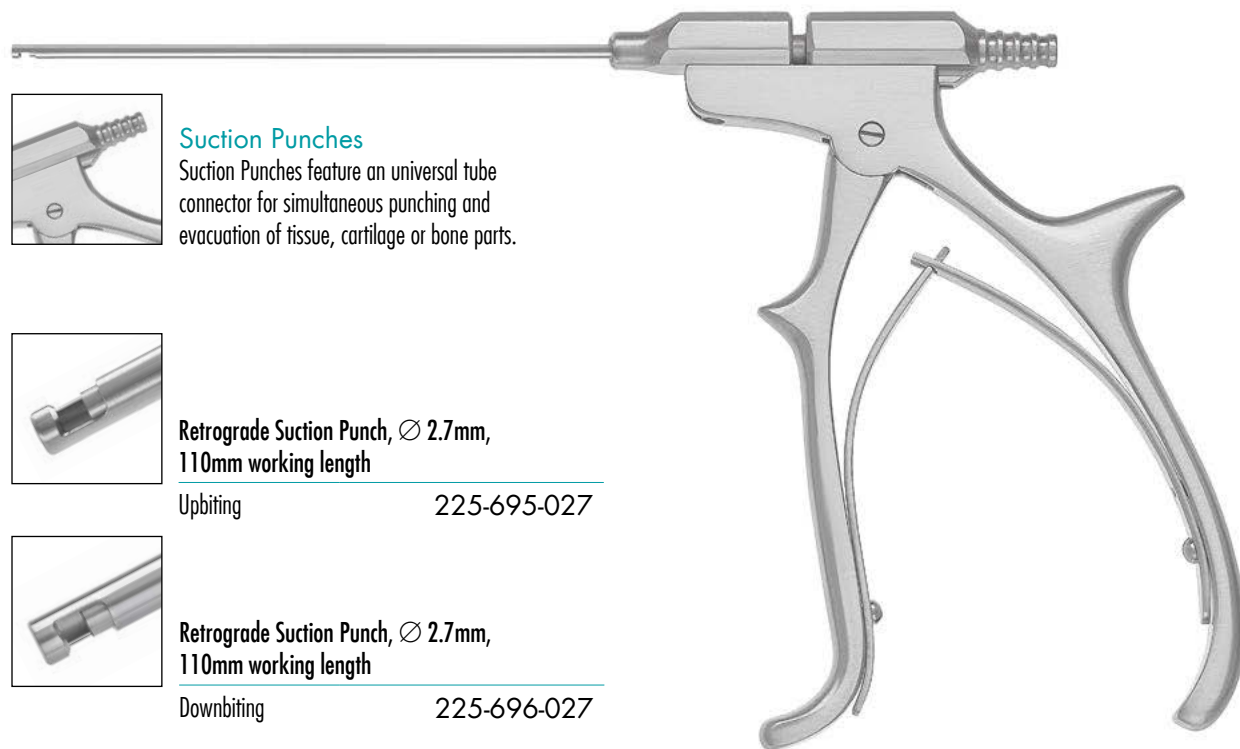

Suction Punches
Suction Punches feature an universal tube connector for simultaneous punching and evacuation of tissue, cartilage or bone parts.



Retrograde Suction Punch, Ø 2.7mm, 110mm working length
Upbiting 225-695-027



Retrograde Suction Punch, Ø 2.7mm, 110mm working length
Downbiting 225-696-027

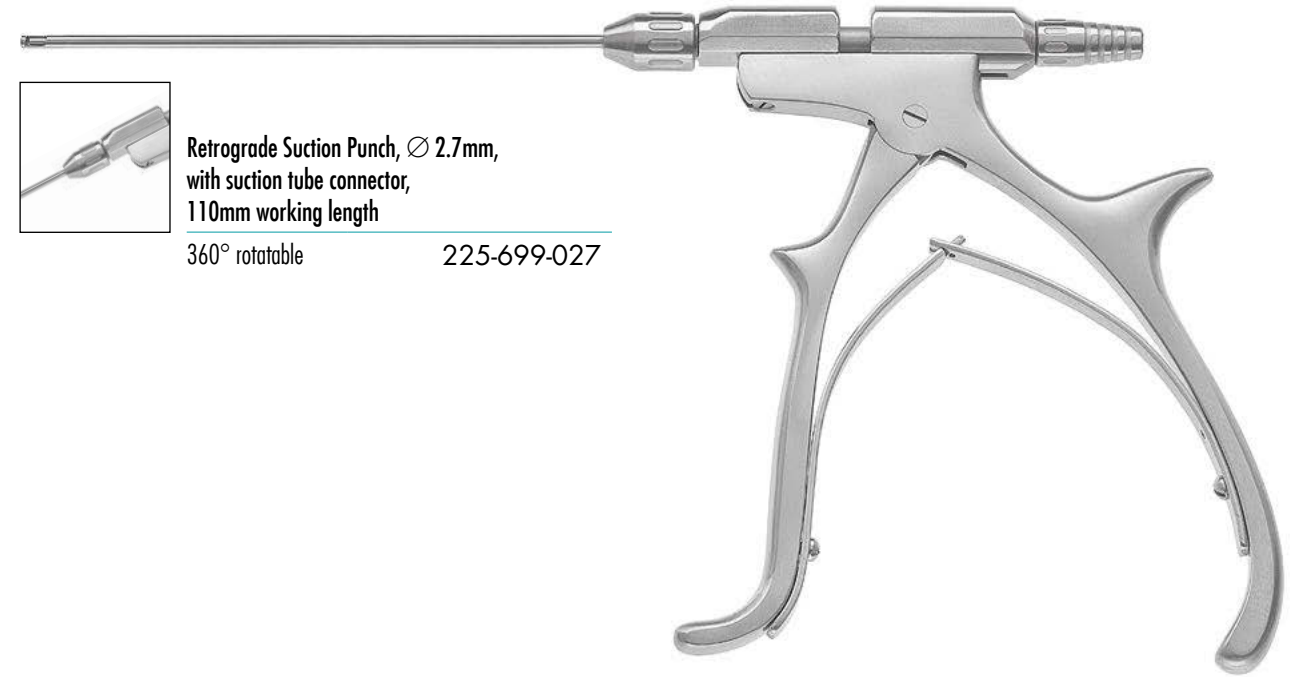

Retrograde Suction Punch, Ø 2.7mm, with suction tube connector, 110mm working length
360° rotatable 225-699-027





Arthroscopic Instruments

Hooks, Probes and Curettes

The Arthvance Instruments provides for all joints and different anatomies the right pattern.



ArthVANCE® Probes



Hook Probe, synthetic handle
225-600-004



Exploring Probe, graduated
straight 225-090-001
curved 225-090-002



Probe Hook, graduated, 75mm working length
Ø1.5mm 225-100-115



Probe Hook, graduated, 140mm working length
Ø2.3mm 225-100-123



Exploring Probe, 5mm graduated, triangular handle
Ø3.5mm 225-400-002
Ø5.0mm 225-400-004



Hook Probe and Retractor, 40mm working length
45° angled, 3mm hook 225-400-103
90° angled, 2mm hook 225-400-102

ArthVANCE® Currettes / Spoons

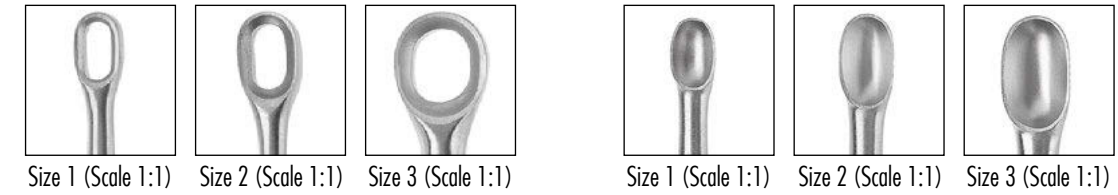

	Curette, 10° angled, 130mm working length		Curette, 20° angled, sharp on both sides, 130mm working length
Size 1 (Scale 1:1)	Size 1, Ø2.0mm 225-600-511	Size 1 (Scale 1:1)	Size 1, Ø2.0mm 225-600-521
Size 2 (Scale 1:1)	Size 2, Ø2.3mm 225-600-512	Size 2 (Scale 1:1)	
Size 3 (Scale 1:1)	Size 3, Ø3.3mm 225-600-513	Size 3 (Scale 1:1)	



Mini Curette, sharp, straight, knurled handle, 90mm working length
Ø1.0mm 225-090-009



Curette, sharp, 30° angled, knurled handle, 130mm working length
Ø3.0mm 225-100-006



Ring Curette, sharp, 30° angled, knurled handle, 130mm working length
Ø3.0mm 225-100-008
Ø5.0mm 225-100-009



Curette, sharp, Ø3mm, triangular handle	Ø7mm
30° angled 225-400-006	30° angled 225-400-009
15° angled 225-400-008	

Spoon, 5° slightly curved, 130mm working length
Size 1, Ø3.0 x 4.4mm 225-600-401
Size 2, Ø3.3 x 5.5mm 225-600-402
Size 3, Ø4.0 x 7.0mm 225-600-403

ArthVANCE® Meniscotomes / Knives

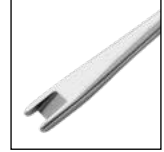

Smillie Meniscotome, straight edge, triangular handle

3.0mm 225-400-020
5.0mm 225-400-022

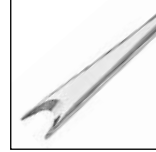

Smillie Meniscotome, curved edge, triangular handle

7.0mm 225-400-023



Smillie Meniscotome, straight edge, knurled handle, 130mm working length

3.0mm 225-100-020
5.0mm 225-100-022



Smillie Meniscotome, curved edge, triangular handle, 130mm working length

7.0mm 225-100-023



Rosette Knife, triangular handle

3.0mm 225-400-025



Banana Knife, smooth, triangular handle

225-400-029



Scalpel Knife, triangular handle

225-400-034



Hook Knife, triangular handle

90° angled 225-400-038



Retrograde Knife, triangular handle

45° 225-400-041



Diamond Rasp, triangular handle

45° angled 225-400-045

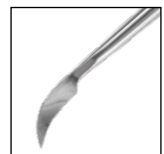

Sickle Knife, triangular handle

225-400-043



Diamond Rasp, triangular handle

90° angled 225-400-090



Rosette Knife, knurled handle, 130mm working length

3.0mm 225-100-025



Banana Knife, smooth, knurled handle, 130mm working length

225-100-029



Scalpel Knife, knurled handle, 130mm working length

225-100-034

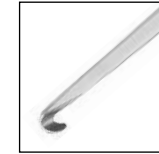

Hook Knife, knurled handle, 130mm working length

90° angled 225-100-038

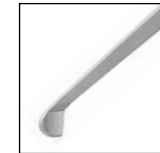

Retrograde Knife, knurled handle, 130mm working length

45° 225-100-041



Smillie Meniscotome, straight cutting edge 130mm working length

3mm wide 225-100-020



Mini Scalpel, knurled handle, 90mm working length

∅ 1.5mm 225-090-006



Mini Knife, knurled handle, 90mm working length

∅ 1.0mm 225-090-007



Mini Sickle Knife, knurled handle, 90mm working length

∅ 1.5mm 225-090-008



Mini Rasp, knurled handle, 90mm working length

concave jaw 225-090-004



Mini Rasp, knurled handle, 90mm working length

convex jaw 225-090-005

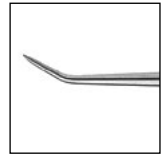

Micro Chondro Pick
25° angled 225-600-125

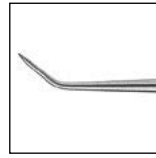

Micro Chondro Pick
45° angled 225-600-145

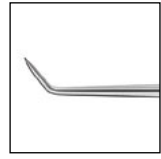

Micro Chondro Pick
60° angled 225-600-160

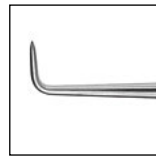

Micro Chondro Pick
90° angled 225-600-190



Mini Lambotte Osteotome, 125mm

2mm	210-136-002
3mm	210-136-003
4mm	210-136-004
5mm	210-136-005
6mm	210-136-006



Walter Osteotome, 190mm

2mm	420-580-002
3mm	420-580-003
4mm	420-580-004



Mallet, lead filled head, 80g
Ø 20mm 210-220-080



Partsch Mallet, 120g
Ø 22mm 210-225-180

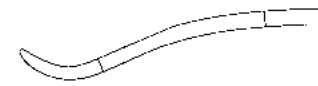

Mini Hohmann, Bone Lever, 2mm tip, 160mm
6mm wide 210-539-060

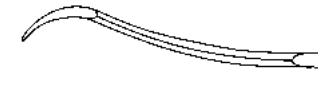

Hohmann, Bone Lever, 2mm tip, 160mm
8mm wide 210-541-080

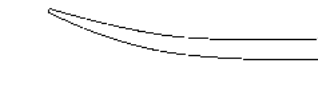

Williger, Elevator, 160mm
5.5mm wide 210-395-160
7.0mm wide 210-396-170



Monopolar Needle Electrode, 90° angled, 115mm working length, 2.4mm connection
Ø 1.5 x 0.6mm 225-710-001



Monopolar Needle Electrode, 90° angled, 115mm working length, 2.4mm connection
Ø 4.0 x 0.6mm 225-710-001

Arthroscopy Shaver System STUNNER S1

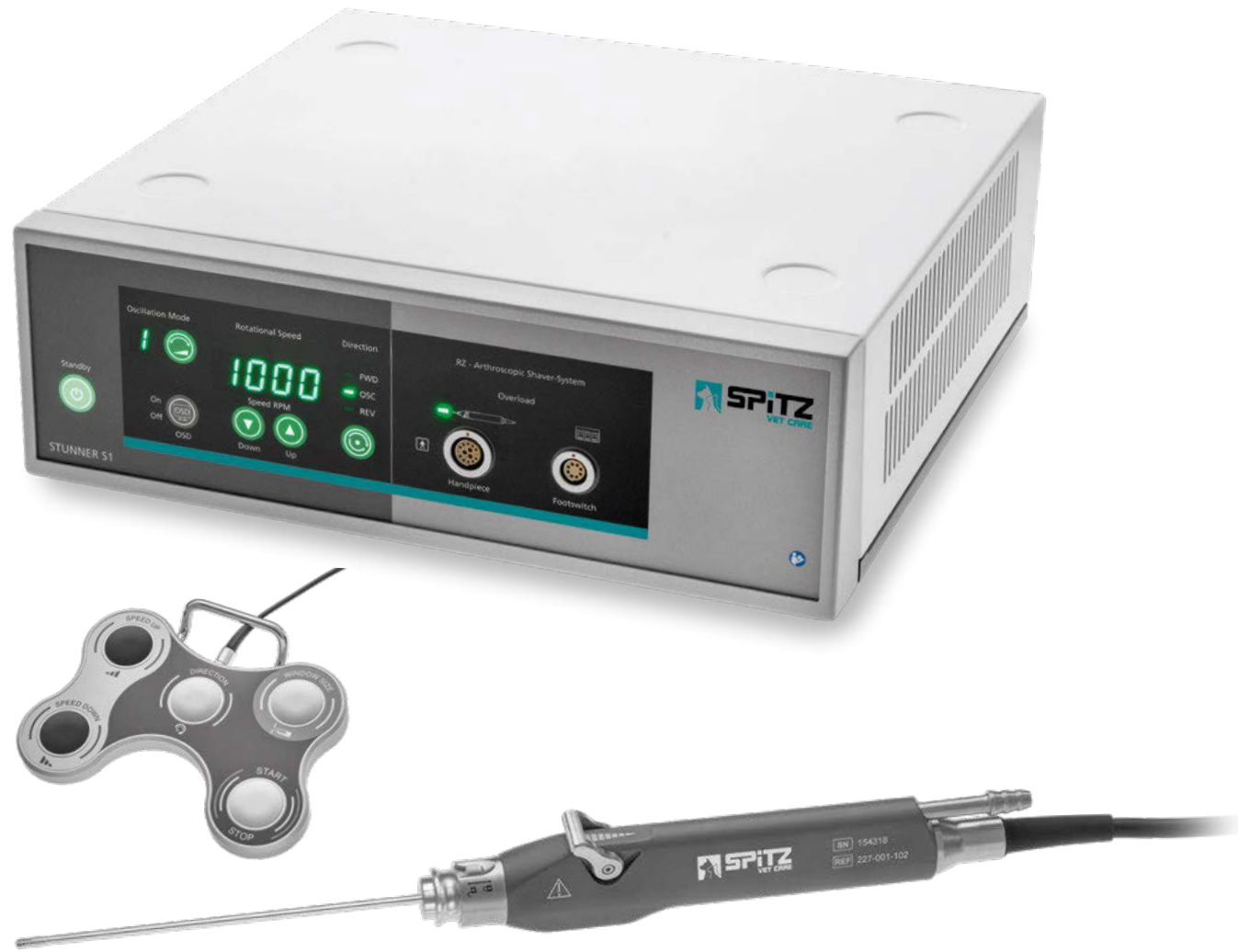

- Features:
- Open window calibration of shaver blades
 - 9 oscillation modes
 - Controlled by buttons on the handpiece or by footswitch
 - Fully autoclavable, small and ergonomic handpiece
 - Dedicated shaver blades

**STUNNER S1 Unit,
complete with Hand Piece and Footswitch**

110 - 230V 227-001-110V

Control Unit
227-001-101V

Hand Piece
227-001-102V

Footswitch
227-001-103V



Shaver Blades



**DR PitBull
Shaver Blades**
The universal blade for
soft and hard tissue



**DR WAVER Cutter
Shaver Blades**
The perfect blade for soft
tissue resection

Non-sterile, 85mm working length
Ø 3.0mm 227-016-013

130mm working length
Ø 3.0mm 227-016-113
Ø 4.0mm 227-016-114

Non-sterile, 85mm working length
Ø 2.0mm 227-016-002
Ø 3.0mm 227-016-003

130mm working length
Ø 3.0mm 227-016-103
Ø 4.0mm 227-016-104



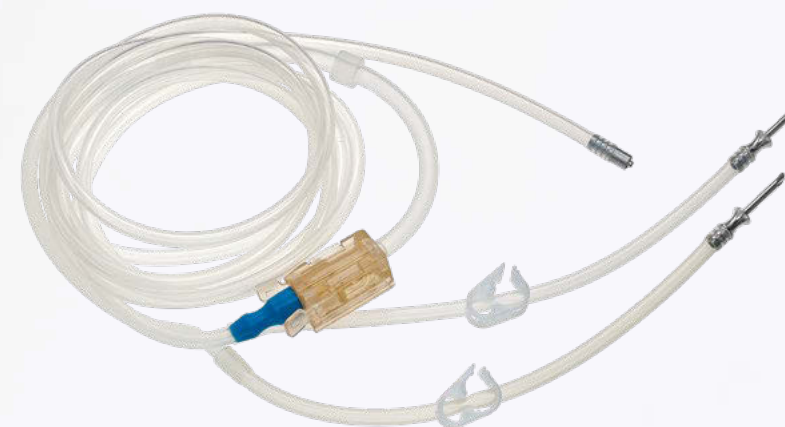

Silicone tubing set (included)

Arthroscopy Pump P1

- Hydrostatic pressure regulation
- Silicone tubing set included (225-910-001)
- Easy to operate, splash-proofed display
- Highly reliable tube guide and handling
- Skid-proof pedestals

Arthroscopy Pump P1

110 - 230V	225-906-000V
Irrigation Tubing Set, silicone, autoclavable (included)	225-910-001
Irrigation Tubing Set, PVC, 20 pcs. daily tube, sterile (optional)	225-910-002
Patient Tube, PVC, 40 pcs., sterile (optional)	225-910-003





Container for Arthroscopy for 8 instruments in upright position with utility space for extra instruments

600-513-000

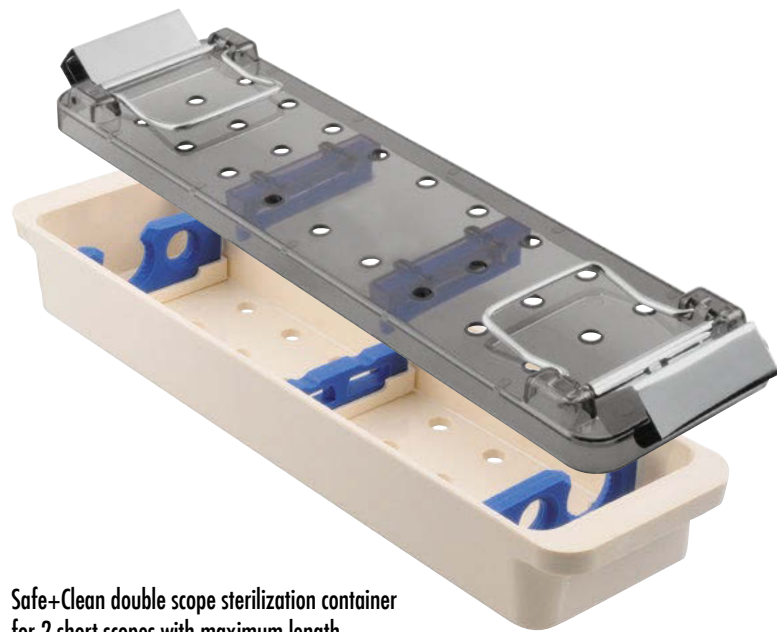

Safe+Clean double scope sterilization container for 2 short scopes with maximum length of 190mm

271 x 70 x 35 mm 600-513-000

SPiTZ VET CARE Endoscope Exchange Program

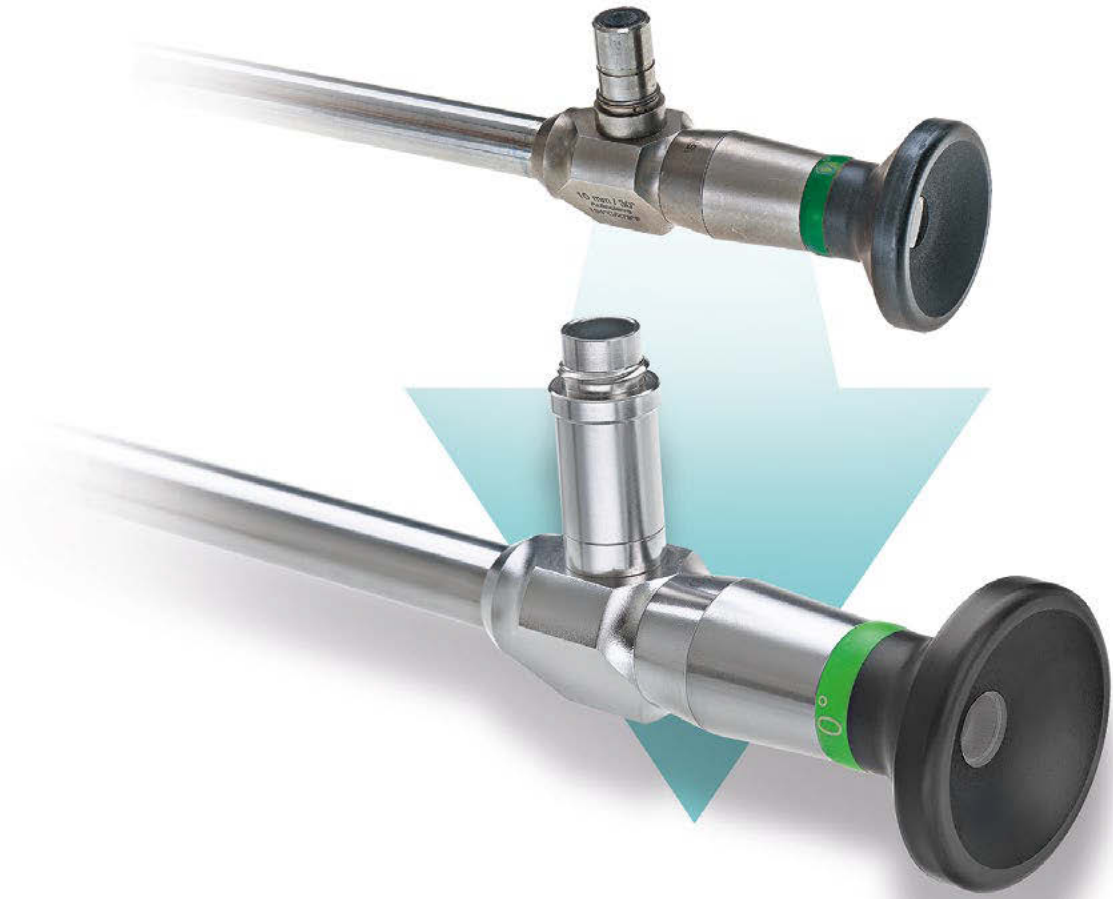

- Collect any kind of broken, damaged or used scope of any company from hospitals, private clinics, etc. and choose one of the listed Endoscopes for an excellent price
- Send us ANY TYPE of scope and choose a new SPiTZ scope
- Receive a brand new SPiTZ Endoscope with full warranty
- All components are new, no „Economy Class“ product, no recycled or reprocessed parts inside
- Fixed prices for a transparent budget

laparoscopy.





SPITZ TELESCOPES

- 3-step light post adapters to connect the most common light cables directly to the endoscope
- Sapphire glasses ensure highest stability against damages on the lens system
- Optimised glass fibre arrangements ensure a uniform image brightness of highest quality
- Full HD and 4K high definition pictures with increased detail-resolution through newest CAD - designed rod - lens systems
- Fully autoclavable at 134°C and 2.3bar

4K LAPAROSCOPES

State-of-the-art Laparoscopes to achieve excellent image quality and finest details in Ultra High Definition.

4K



4K Laparoscope, Ø 10mm, 330mm working length

0°	300-100-400
30°	300-100-430

450mm working length

0°	300-200-400
30°	300-200-430



4K Laparoscope, Ø 5mm, 300mm working length

0°	300-155-400
30°	300-155-430

450mm working length

0°	300-255-400
30°	300-255-430

FullHD Laparoscopes



Laparoscope, Ø 10mm, 330mm working length

0°	300-091-100
30°	300-091-130
45°	300-091-145
70°	300-091-170

430mm working length

0°	300-091-430
30°	300-091-433



Laparoscope, Ø 5mm, 300mm working length

0°	300-092-100
30°	300-092-130



Mini-Laparoscope, Ø 2.9mm, 207mm working length

0°	300-097-100
30°	300-097-130

FULL HD



Operating Laparoscope, Ø 10mm, with instrument channel
270mm working length, parallel view

0°	300-099-006
----	-------------



Operating Laparoscope, Ø 10mm, with instrument channel
270mm working length, lateral view

0°	300-099-106
----	-------------

FULL HD

Suction & Irrigation



Suction or irrigation tube with Luer-Lock, 4 x 4 holes and stopcock, Ø 5mm

330mm working length	300-006-305
450mm working length	300-006-455



Suction or irrigation tube with Luer-Lock, 4 holes, Ø 5mm

330mm working length	300-008-335
----------------------	-------------



Suction and irrigation cannula with Luer-Lock, 4 holes, 340mm working length

Ø 3mm	300-192-003
Ø 5mm	300-192-005
Ø 10mm	300-192-010
250mm working length	
Ø 3mm	300-192-253



Suction and irrigation handle, rotating 2-way lever mechanism and 2 big universal tube adapters, with luer-lock

300-192-000



Suction and irrigation cannula, 4 holes, 340mm working length

Ø 3mm	300-172-003
Ø 5mm	300-172-005
Ø 10mm	300-172-010

250mm working length

Ø 3mm	300-172-253
-------	-------------



4x4 holes, 340mm working length

Ø 3mm	300-173-003
-------	-------------

250mm working length

Ø 3mm	300-173-253
-------	-------------





Pistol-shaped suction and irrigation handle with 2-way valve and 2 large universal tube connectors

300-166-100

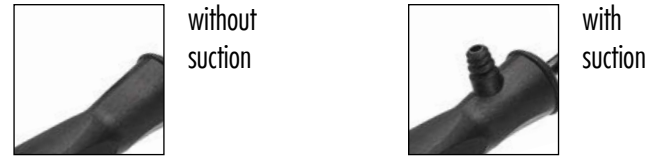

HF Electrodes



	Monopolar Spatula Electrode, Ø 5mm, with ceramic tip, 360mm working length
without suction	300-144-002
with suction	300-145-003

	Monopolar L-Hook Electrode, Ø 5mm, with ceramic tip, 360mm working length
without suction	300-144-005
with suction	300-145-005

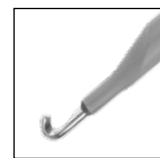
	Monopolar J-Hook Electrode, Ø 5mm, with ceramic tip, 360mm working length
without suction	300-144-004
with suction	300-145-004

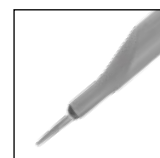
	Monopolar Needle Electrode, Ø 5mm, with ceramic tip, 360mm working length
without suction	300-144-006
with suction	300-145-006

Monopolar HF Cables

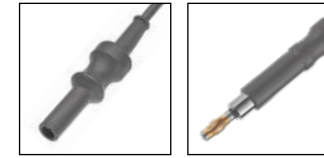

Erbe/ACC/ICC	
3m	700-101-030
5m	700-101-050

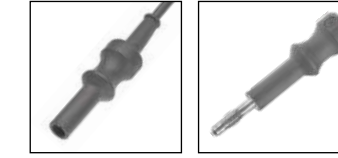

Erbe/Martin/Berchtold	
3m	700-280-030
5m	700-280-050

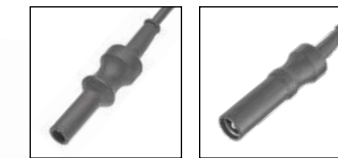

Martin/Berchtold	
3m	700-285-030
5m	700-285-050

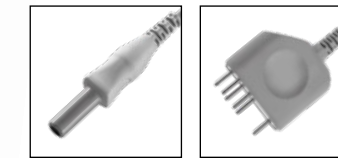

SPITZ HF Unit SDS Plug	
3m	700-501-300
5m	700-501-500

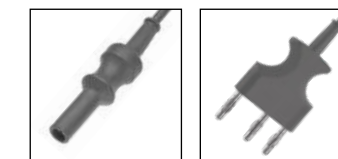

SPITZ HF Unit Standard Plug	
3m	700-501-303
5m	700-501-503

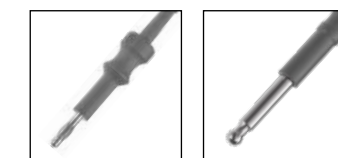

Bovie, Valleylab, Conmed	
3m	700-370-030
5m	700-370-050

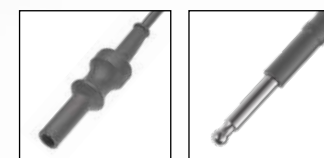

Bovie, Valleylab, Conmed	
3m	700-360-031
5m	700-360-051

Multiport Trocar System

- Reusable and autoclavable seals
- Easy opening by pushing the lever
- Stainless Steel stopcock
- Ergonomic Stainless Steel housing
- Self-centering sleeves

Color Coding	
Ø 5.5mm	●
Ø 11.0mm	●
Ø 13.0mm	●



Complete with Smooth Metal Sleeve, 105mm working length A+B

Ø 5.5mm	300-220-055
Ø 11.0mm	300-220-011
Ø 13.0mm	300-220-013

150mm working length

Ø 5.5mm	300-220-155
Ø 11.0mm	300-220-111
Ø 13.0mm	300-220-113

Spare Sleeve A

Ø 5.5mm	300-220-255
Ø 11.0mm	300-220-211
Ø 13.0mm	300-220-213



Multiport Mini Trocar, 70mm working length A+B

Ø 3.5mm	300-112-035
---------	-------------



Complete with Threaded Metal Sleeve, 105mm working length A+B

Ø 5.5mm	300-221-055
Ø 11.0mm	300-221-011
Ø 13.0mm	300-221-013

Spare Sleeve A

Ø 5.5mm	300-221-255
Ø 11.0mm	300-221-211
Ø 13.0mm	300-221-213



Complete with Threaded Metal Sleeve, self-cutting 105mm working length A+B

Ø 5.5mm	300-226-055
Ø 11.0mm	300-226-011
Ø 13.0mm	300-226-013

Spare Sleeve A

Ø 5.5mm	300-236-255
Ø 11.0mm	300-236-211
Ø 13.0mm	300-223-213



MultiPort lever



Color Coded



Metal Housing



Complete with Smooth Synthetic Sleeve, 105mm working length A+B

Ø 5.5mm	300-223-055
Ø 11.0mm	300-223-011
Ø 13.0mm	300-223-013

Spare Sleeve A

Ø 5.5mm	300-233-255
Ø 11.0mm	300-233-211
Ø 13.0mm	300-233-213



Complete with Smooth Metal Sleeve, oblique 105mm working length A+B

Ø 5.5mm	300-222-055
Ø 11.0mm	300-222-011
Ø 13.0mm	300-222-013

Spare Sleeve A

Ø 5.5mm	300-222-255
Ø 11.0mm	300-222-211
Ø 13.0mm	300-222-213



Complete with Threaded Synthetic Sleeve, 105mm working length A+B

Ø 5.5mm	300-224-055
Ø 11.0mm	300-224-011
Ø 13.0mm	300-224-013

Spare Sleeve A

Ø 5.5mm	300-234-255
Ø 11.0mm	300-234-211
Ø 13.0mm	300-234-213

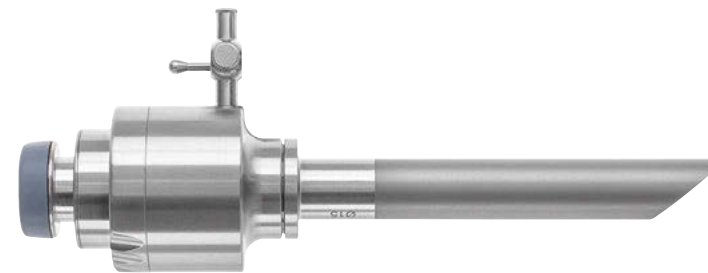

Multiport Special Sized Trocar, oblique sleeve, 110mm working length A+B

Ø 15.0mm	300-020-015
----------	-------------

119mm working length A+B

Ø 20.0mm	300-020-020
----------	-------------

Siliport Trocar System

- Reusable and autoclavable seals
- Reusable and autoclavable silicon valve
- Stainless Steel stopcock
- Lightweight synthetic housing
- Self-centering sleeves

Color Coding	
Ø 5.5mm	●
Ø 11.0mm	●
Ø 13.0mm	●



Complete with Smooth Metal Sleeve, 105mm working length A+B

Ø 5.5mm	300-230-055
Ø 11.0mm	300-230-011
Ø 13.0mm	300-230-013

150mm working length

Ø 5.5mm	300-230-155
Ø 11.0mm	300-230-111
Ø 13.0mm	300-230-113

Spare Sleeve A

Ø 5.5mm	300-220-255
Ø 11.0mm	300-220-211
Ø 13.0mm	300-220-213



Complete with Threaded Metal Sleeve, 105mm working length A+B

Ø 5.5mm	300-231-055
Ø 11.0mm	300-231-011
Ø 13.0mm	300-231-013

Spare Sleeve A

Ø 5.5mm	300-221-255
Ø 11.0mm	300-221-211
Ø 13.0mm	300-221-213



Complete with Threaded Metal Sleeve, self-cutting 105mm working length A+B

Ø 5.5mm	300-236-055
Ø 11.0mm	300-236-011
Ø 13.0mm	300-236-013

Spare Sleeve A

Ø 5.5mm	300-236-255
Ø 11.0mm	300-236-211
Ø 13.0mm	300-223-213



Lightweight housing



Color Coded



Complete with Smooth Synthetic Sleeve, 105mm working length A+B

Ø 5.5mm	300-233-055
Ø 11.0mm	300-233-011
Ø 13.0mm	300-233-013

Spare Sleeve A

Ø 5.5mm	300-233-255
Ø 11.0mm	300-233-211
Ø 13.0mm	300-233-213



Complete with Smooth Metal Sleeve, oblique 105mm working length A+B

Ø 5.5mm	300-232-055
Ø 11.0mm	300-232-011
Ø 13.0mm	300-232-013

Spare Sleeve A

Ø 5.5mm	300-222-255
Ø 11.0mm	300-222-211
Ø 13.0mm	300-222-213



Complete with Threaded Synthetic Sleeve, 105mm working length A+B

Ø 5.5mm	300-234-055
Ø 11.0mm	300-234-011
Ø 13.0mm	300-234-013

Spare Sleeve A

Ø 5.5mm	300-234-255
Ø 11.0mm	300-234-211
Ø 13.0mm	300-234-213



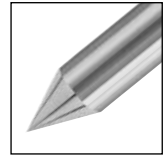

Standard Trocar, reusable, cutting conical tip

Ø 3.5mm	300-240-035
Ø 5.5mm	300-240-055
Ø 11.0mm	300-240-011
Ø 13.0mm	300-240-013
Ø 15.0mm	300-240-015
Ø 20.0mm	300-240-020

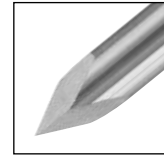

Standard Trocar, reusable, cutting pyramidal tip

Ø 3.5mm	300-241-035
Ø 5.5mm	300-241-055
Ø 11.0mm	300-241-011
Ø 13.0mm	300-241-013
Ø 15.0mm	300-241-015
Ø 20.0mm	300-241-020

XL Trocar, 150mm working length

Ø 5.5mm	300-241-155
---------	-------------

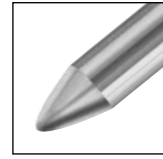

Hasson Trocar, reusable, atraumatic blunt ball tip

Ø 3.5mm	300-242-035
Ø 5.5mm	300-242-055



Safety Trocar System

160mm working length

Ø 5.5mm	300-152-055
---------	-------------

170mm working length

Ø 11.0mm	300-152-011
Ø 12.5mm	300-152-012



Shielded trocar tip



Sharp trocar tip

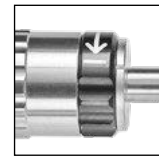

Safety mechanism



Flexible Thorax Trocar System
100mm working length A+B

Ø 5.5mm	●	300-020-255
Ø 11.0mm	●	300-020-211

Obturator B

Ø 5.5mm	300-023-255
Ø 11.0mm	300-023-711

Flexible Thorax Trocar System
70mm working length A+B

Ø 5.5mm	●	300-020-755
Ø 11.0mm	●	300-020-711

Obturator B

Ø 5.5mm	300-023-755
Ø 11.0mm	300-023-711



Sealing Caps, 10 pcs.

for Ø 3.5mm	●	300-250-035
for Ø 5.5mm	●	300-250-055
for Ø 11.0mm	●	300-250-011
for Ø 13.0mm	●	300-250-013



Inner Gaskets for MultiPort, 10 pcs.

for Ø 3.5mm	●	300-250-235
for Ø 5.5mm	●	300-250-255
for Ø 11.0mm	●	300-250-211
for Ø 13.0mm	●	300-250-213
for Ø 15.0mm	●	300-250-215
for Ø 20.0mm	●	300-250-220



Gaskets for MultiPort, 10 pcs.

for Ø 3.5mm	300-250-135
for Ø 5.5mm	300-250-135
for Ø 11.0mm	300-250-111
for Ø 13.0mm	300-250-111



Reducer Sleeve, 60mm

Ø 10mm → 5.0 mm	300-012-106
Ø 11mm → 5.5 mm	300-012-116
Ø 12.5mm → 5.5 mm	300-012-121



Fixable Sliding Hasson Cone

Ø 11mm	300-014-711
--------	-------------



Reducer Clip with silicone band

Ø 11mm → 5.5mm	300-021-355
Ø 13mm → 5.5mm	300-021-305
Ø 13mm → 10.0mm	300-021-310



Veress Insufflation Needle, Ø 2.0mm

100mm working length	300-195-100
120mm working length	300-195-120
150mm working length	300-195-150
170mm working length	300-195-170
200mm working length	300-195-200

Ø 2.7mm

100mm working length	300-195-300
120mm working length	300-195-320
150mm working length	300-195-350
170mm working length	300-195-370

Ring Handle Instruments

- Reusable 3-piece instruments
- Ergonomic design
- Interchangeable inserts
- Modular, cost-effective system



Outer Sheath, insulated, 330mm
 Ø 5mm 300-660-005
 Ø 10mm 300-660-010



Maryland Extra Fine Dissector, gently curved, double action, Ø 5mm

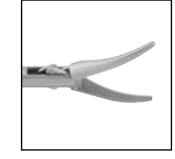

Insert only

300-400-731



Complete Instrument with shaft and handle 300-750-101
 300-420-731

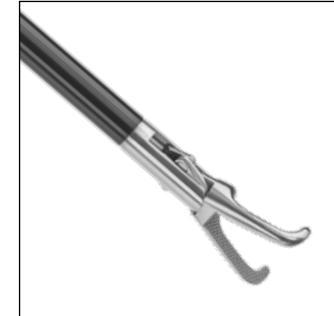

Dissecting Grasping Forceps, fine serrated jaws, right angled, double action, Ø 5mm



Insert only

300-400-735



Complete Instrument with shaft and handle 300-750-101
 300-420-735



PEEK Polymer Handle with HF connection
 300-750-101



PEEK Polymer Handle with ratchet and HF connection
 300-750-103



PEEK Polymer Handle with hook up ratchet and HF connection
 300-750-105



PEEK Polymer Handle with swing-away ratchet and HF connection
 300-750-106



Metal Handle with inner ratchet
 300-750-020



Axial Handle with catch, one golden ring
 300-750-115

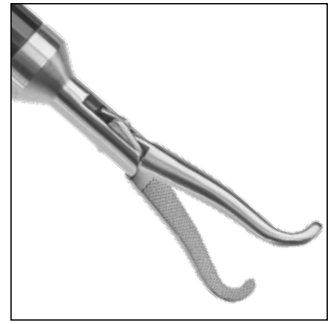

Overholt Dissecting Forceps,
90° angled jaws, double action, Ø 10mm

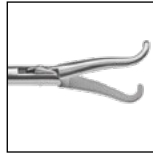

Insert only

300-400-741



Complete Instrument with shaft
and handle 300-750-101

300-420-741



DeBaKey Pick-Up Forceps, 38mm jaws,
22mm serration, double action, Ø 5mm



Insert only

300-400-243



Complete Instrument with shaft
and handle 300-750-103

300-440-243



Complete Instrument with shaft
and handle 300-750-105

300-470-243



DeBaKey Grasping Forceps, 25mm jaws,
double action, Ø 5mm



Insert only

300-400-244



Complete Instrument with shaft
and handle 300-750-103

300-440-244



Complete Instrument with shaft
and handle 300-750-105

300-470-244



Johans Grasping Forceps,
20mm fenestrated jaws
double action, Ø 5mm

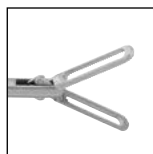

Insert only

300-400-289



Complete Instrument with shaft
and handle 300-750-103

300-440-289



Complete Instrument with shaft
and handle 300-750-105

300-470-289

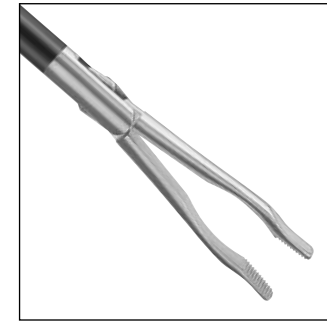

Babcock Paddle Grasping Forceps,
flat paddles, double action, Ø 5mm

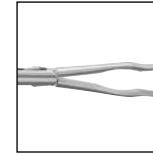

Insert only

300-400-250



Complete Instrument with shaft
and handle 300-750-103

300-440-250



Complete Instrument with shaft
and handle 300-750-105

300-470-250



Babcock Grasping Forceps,
single action, Ø 5mm



Insert only

300-400-251



Complete Instrument with shaft
and handle 300-750-101

300-420-251



Babcock Grasping Forceps, rounded jaws
fine serrations, double action, Ø 5mm



Insert only

300-400-252



Complete Instrument with shaft
and handle 300-750-103

300-440-252



Complete Instrument with shaft
and handle 300-750-105

300-470-252



Grasping Forceps with biopsy cup,
heavy pattern, double action, Ø 5mm



Insert only

300-400-000



Complete Instrument with shaft
and handle 300-750-103

300-440-000



Complete Instrument with shaft
and handle 300-750-105

300-460-000



Bullnose Grasping Forceps, heavy pattern, double action, Ø 5mm



Insert only

300-400-001



Complete Instrument with shaft and handle 300-750-103

300-440-001



Complete Instrument with shaft and handle 300-750-105

300-460-001

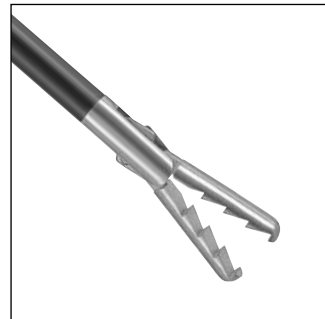

Alligator Grasping Forceps, strong retrograde serrations, double action, Ø 5mm

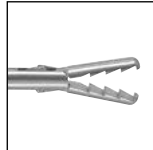

Insert only

300-400-010



Complete Instrument with shaft and handle 300-750-103

300-440-010



Complete Instrument with shaft and handle 300-750-105

300-460-010



Shark Grasping Forceps, very sharp, aggressive lateral retrograde teeth, double action, Ø 5mm



Insert only

300-400-048



Complete Instrument with shaft and handle 300-750-103

300-440-048



Complete Instrument with shaft and handle 300-750-105

300-460-048



Biopsy Forceps, 2 pinholes, sharp oval cups, double action, Ø 5mm



Insert only

300-400-080



Complete Instrument with shaft and handle 300-750-101

300-420-080

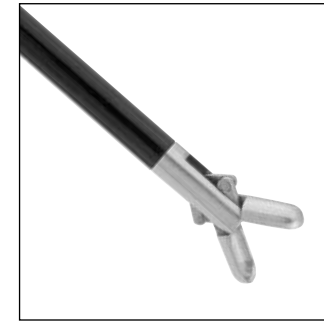

Biopsy Forceps, sharp oval cups, double action, Ø 5mm

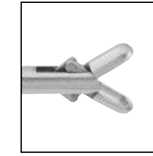

Insert only

300-400-082



Complete Instrument with shaft and handle 300-750-101

300-420-082



Hook Scissors, round cutting blades, single action, Ø 5mm



Insert only

300-400-060



Complete Instrument with shaft and handle 300-750-101

300-420-060

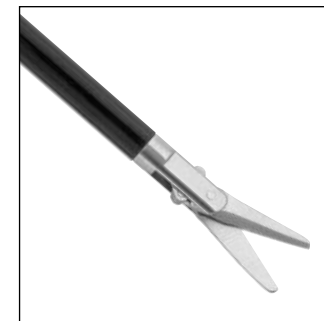

Metzenbaum Scissors, 12mm short blades, slightly curved, double action, Ø 5mm

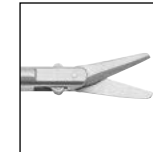

Insert only

300-400-067



Complete Instrument with shaft and handle 300-750-101

300-420-067

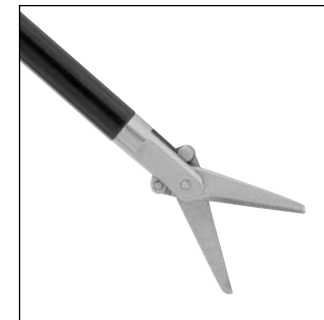

Metzenbaum Scissors, 15mm medium blades, straight, double action, Ø 5mm



Insert only

300-400-068



Complete Instrument with shaft and handle 300-750-101

300-420-068



Metzenbaum Scissors, 12mm short blades, straight, double action, Ø 5mm

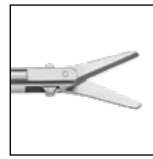

Insert only

300-400-069



Complete Instrument with shaft and handle 300-750-101

300-420-069



Metzenbaum Scissors, 15mm long blades, slightly curved, double action, Ø 5mm

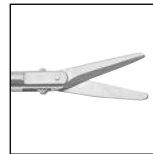

Insert only

300-400-070



Complete Instrument with shaft and handle 300-750-101

300-420-070

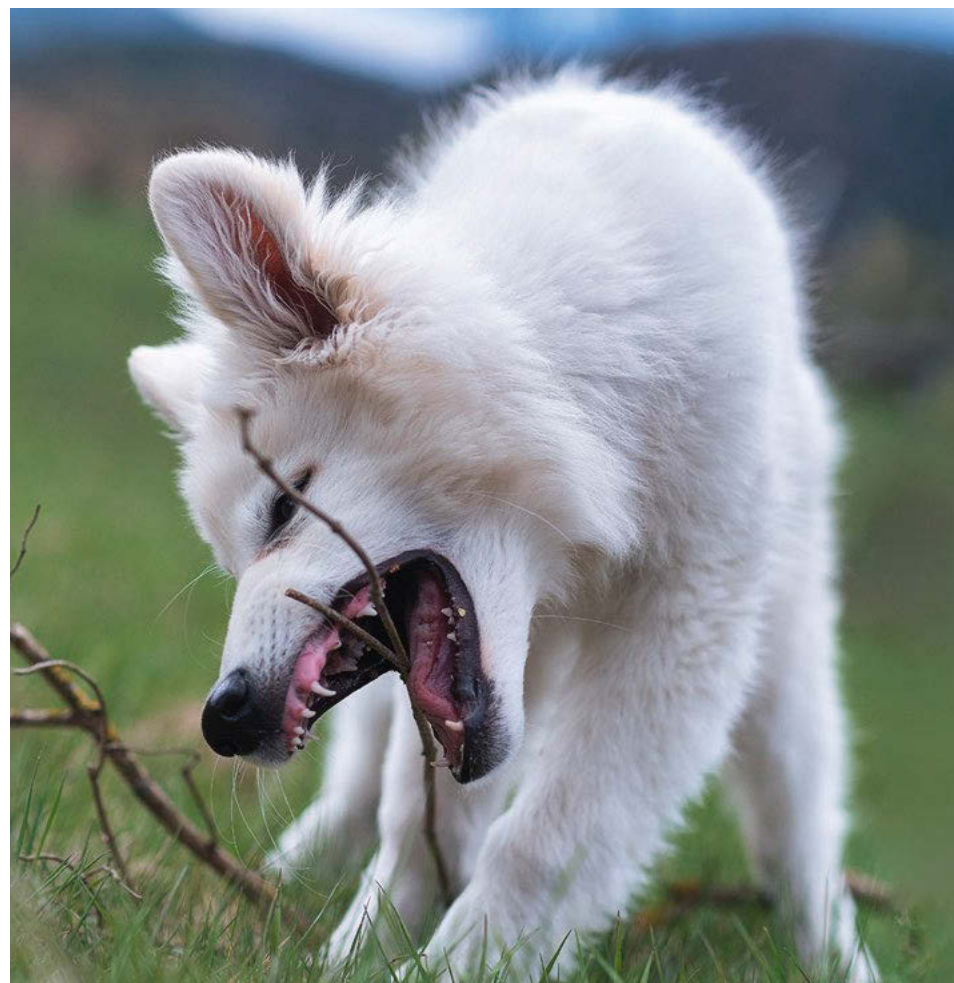

Instruments

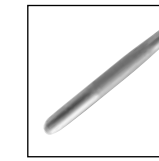

Palpation Probe, graduated, 330mm working length

Ø 2.8mm 300-193-303

330mm working length

Ø 5.0mm 300-193-335

300mm working length

Ø 5.0mm 300-193-305

400mm working length

Ø 5.0mm 300-193-405

Ø 10.0mm 300-193-410

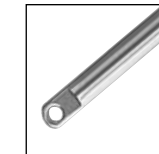

Knot Pusher, closed, 330mm working length

Ø 4mm 300-030-004

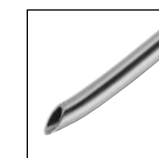

Guide Tube for Cholangiography Catheter, 330mm working length

Ø 5mm 300-193-330



Endo Dilator Speculum

195mm 300-023-100

Endoscopic Needle Holder

- One-piece Instrument
- Ergonomic and extremely lightweight (120g)
- Aluminium anodized handle
- Corrosion protection



Lightweight design with satin black surface



65° Luer-Lock flushing port for optimal accessibility



6-tooth ratchet for always optimal positioning, with overload protection

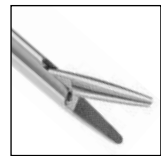

Straight, TC Inserts, 330mm working length
Ø 5mm 300-300-130

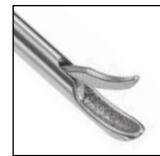

Concave/convex, diamond dusted jaw, 330mm working length
Ø 5mm 300-300-142



Fan Retractors & Band Passer

- One-piece Instrument
- Flush Port System
- Vertical adjustment of max. 50°

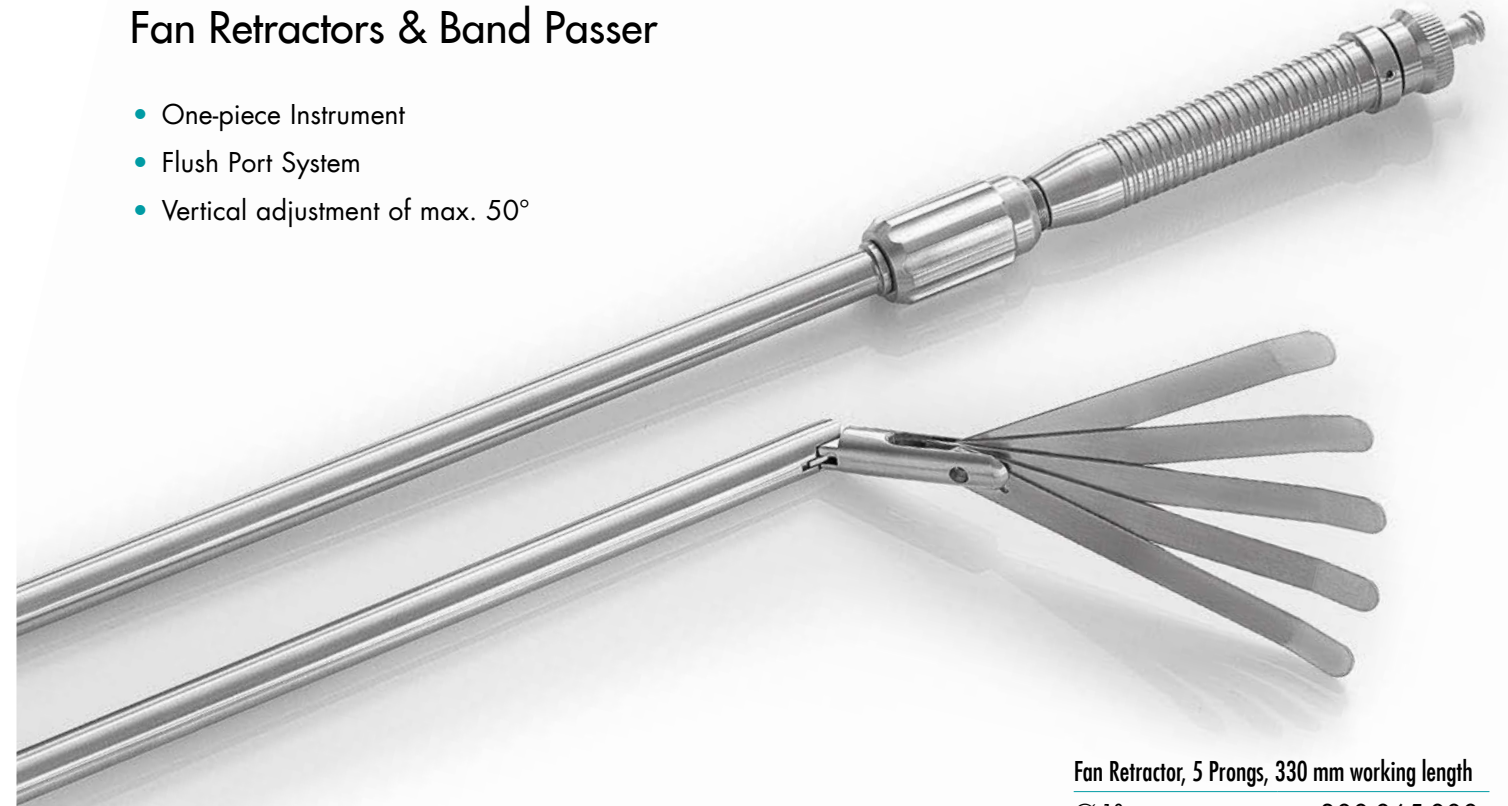

Fan Retractor, 5 Prongs, 330 mm working length
Ø 10mm 300-065-000

- Easy to use with 5.0 / 5.5 trocar sleeves
- Carbon handle
- Nitinol wire to straighten

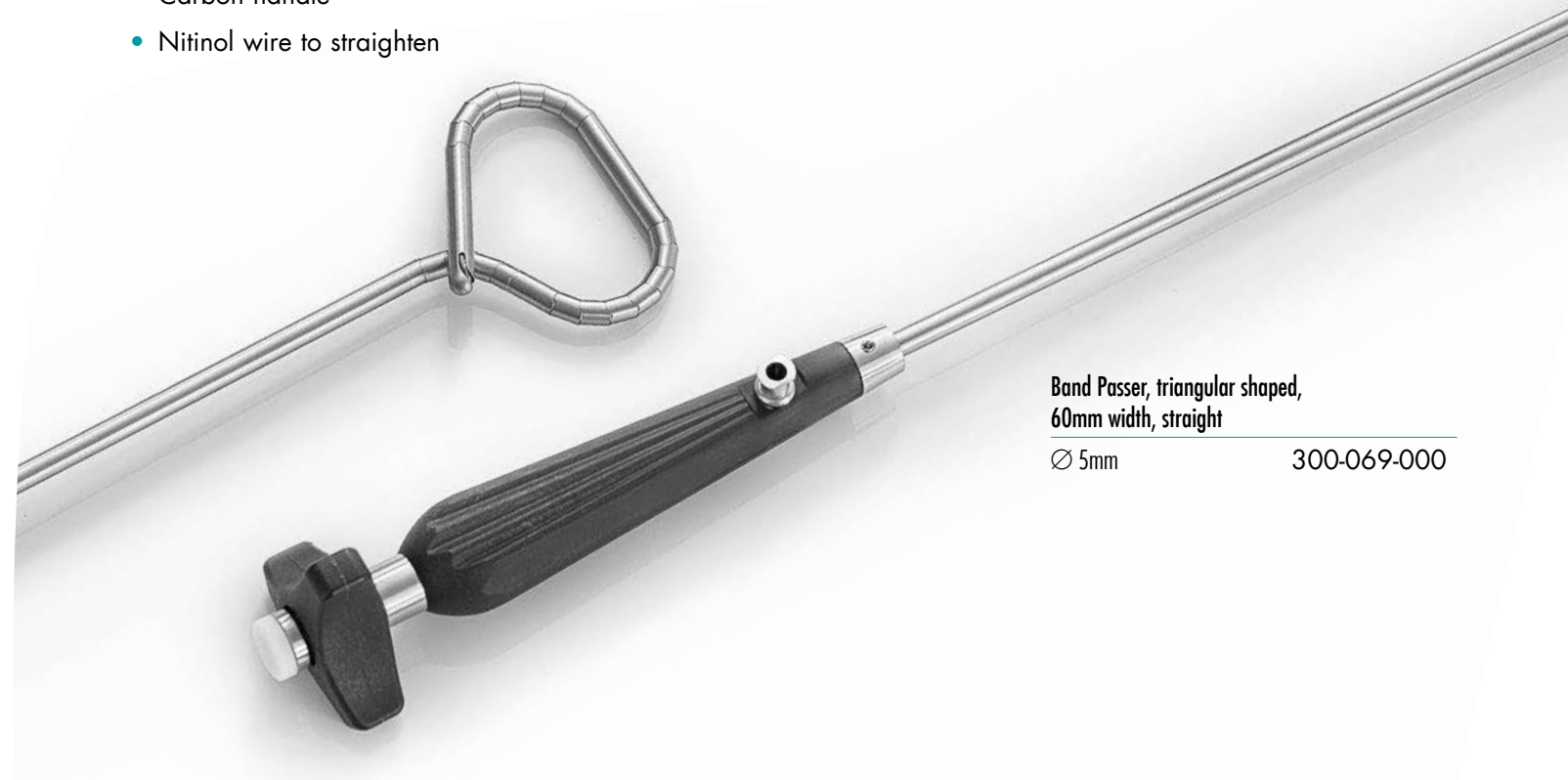

Band Passer, triangular shaped, 60mm width, straight
Ø 5mm 300-069-000

Nathanson Liver Retractor

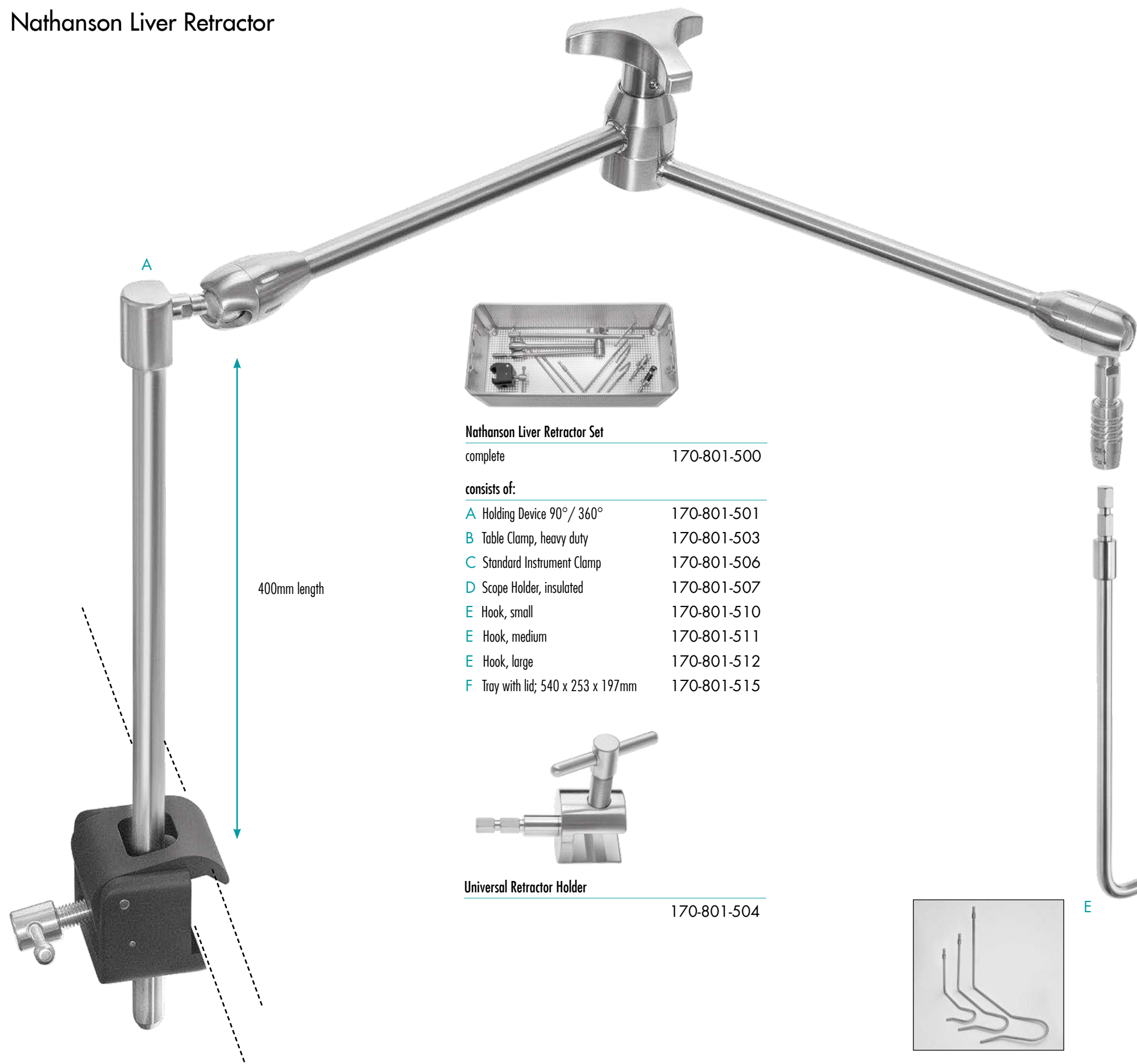

Nathanson Liver Retractor Set

complete	170-801-500
consists of:	
A Holding Device 90° / 360°	170-801-501
B Table Clamp, heavy duty	170-801-503
C Standard Instrument Clamp	170-801-506
D Scope Holder, insulated	170-801-507
E Hook, small	170-801-510
E Hook, medium	170-801-511
E Hook, large	170-801-512
F Tray with lid; 540 x 253 x 197mm	170-801-515

Universal Retractor Holder

170-801-504

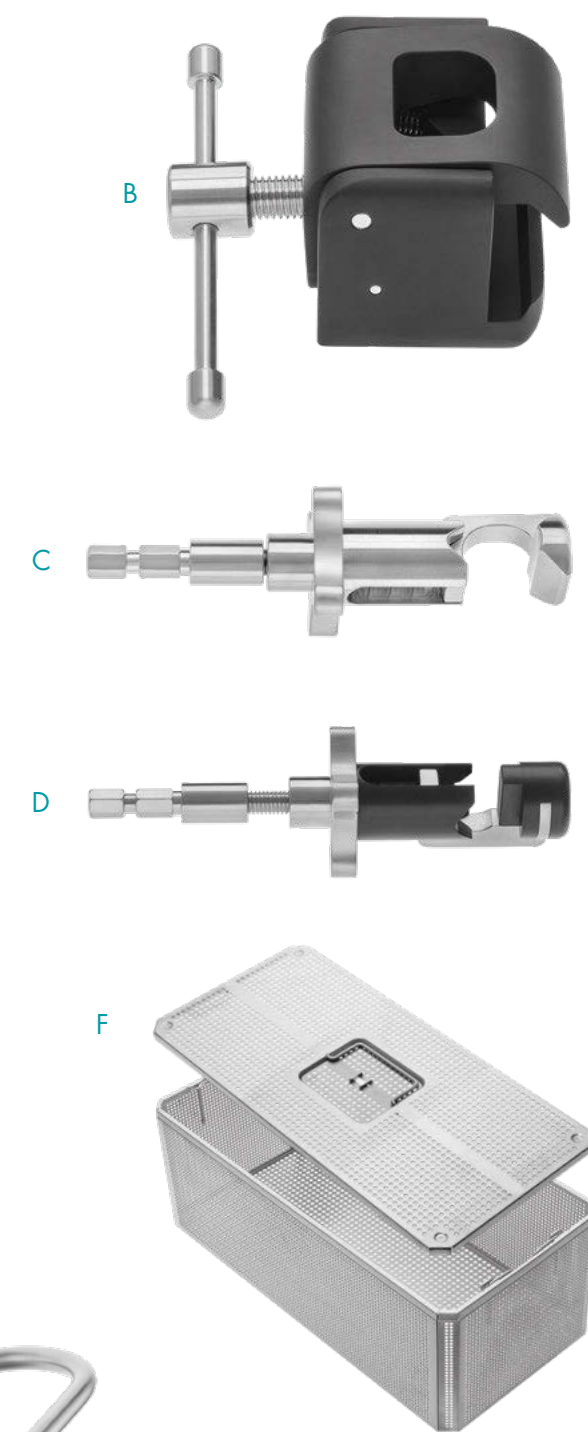

E

devices.



Our complete system for high-definition endoscopic, laparoscopic and arthroscopic surgery. We support the needs you have and provide you the options for your individual configuration.



Mobile endoscopy becomes possible with this High Definition camera that allows endoscopic examination with all required parts in one complete set. Integrated illumination and a high-performance camera head, powered by an external Desktop-Computer or Laptop via USB 3.0 makes examination and clinical surgery possible.

- Full HD (1920 x 1080) recording function (images / video)
- Powered by USB connection (USB 3.0 required)
- Long-life LED illumination
- Programmable camera head with adjustable brightness
- Easy software installation and interface (Software incl. patient management/storage)
- Lightweight, ready-to use design



300-001-480
FULL HD CAMERA SET
consisting of:

- A Camera head
- B Endoscope coupler
- C Light source
- D Suitcase
- E Software



High-Performance HD Camera Head



Programmable buttons and adjustable brightness button

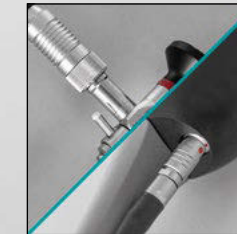

Lightsource can be connected directly to Endoscope and camera head



Just a USB 3.0 port ist required





4K 3-Chip UHD Camera K 4000
300-001-840V

- Features:
- 4K UHD resolution with 3-Chip technology
 - Image algorithms enhancement of color and structure
 - True natural colors for excellent live surgery imaging
 - Recording function (video and picture)
 - Camera head with 4 push buttons
 - Boost function
 - Zoom, freeze, fog reduction
 - 10 USER modes configurations
 - Multilingual menu
 - SDI 4K Output

4K
Ultra High Definition Quality
3840 x 2160 PIXELS



Recording function on USB pen drive



Camera head with 4 raised push buttons



UHD -Chip Camera Head
(included) 300-001-841



Delivery contains:

- Main Unit (300-001-840V)
- Camera head (300-001-841)
- HDMI cable
- USB Pen Drive
- Mains cable
- Operating manual

Features:

- Pure Natural Colors technology
- Multitude of digital video outputs for best possible picture transmission to medical grade monitors
- Ergonomic camera head with 3 programmable remote control buttons
- User-friendly multilingual menu allows a large variety of setups for individual procedures and surgeons preferences
- Full HD 60fps video recording
- Full HD image saving
- USB pen drive included
- Text generator (optional with keyboard)
- Documentation System

FULL HD
1-CHIP FULL HD
1920 x 1080
PIXELS



Delivery contains:

- Main Unit
- Camera head
- HDMI-DVI cable
- HDMI cable
- S-Video cable
- RGB cable
- BNC cable
- USB Pen Drive
- Mains cable
- Operating manual



3-MOS Camera Head
 (included) 300-001-602



HD-Camera F2 Pro
 300-001-601V



3-Chip Camera F4
300-001-804V

- Features:
- Full HD-Camera with latest 3-MOS technology for brilliant picture quality
 - Pure Natural Colors technology
 - Multitude of digital video outputs for best possible picture transmission to medical grade monitors
 - Ergonomic camera head with 3 programmable remote control buttons
 - User-friendly multilingual menu allows a large variety of setups for individual procedures and surgeons preferences
 - Full HD 60fps video recording
 - Full HD image saving
 - USB pen drive included
 - Text generator (optional with keyboard)
 - Documentation System



Delivery contains:

- Main Unit
- Camera head
- HDMI-DVI cable
- HDMI cable
- S-Video cable
- USB Pen Drive
- Mains cable
- Operating manual



3-MOS Camera Head
(included) 300-001-802



TV Coupler for SPiTZ Camera Devices



TV Coupler, manual lock, C-mount, soakable, FULL HD

f=14mm	300-001-813
f=25mm	300-001-814
f=28mm	300-001-815



Zoom TV Coupler, C-mount, soakable, FULL HD

f=15 - 36mm	250-015-036
-------------	-------------



LUMEN LED 1 Light Source

300-900-180V



Features:

- Daylight quality
- 20.000h lamp lifetime
- Manual or automatic light control
- Waterproof touch control panel
- Low heat conduction by improved LED technology

Delivery contains:

- Main Unit
- BNC cable
- Mains cable
- Operating manual



Automatic or manual light intensity control



Digital light intensity display



Fiber optic light cable, without adapter pieces

Ø 2.5mm, 2300mm	250-025-230
Ø 2.5mm, 3000mm	250-025-300
Ø 3.5mm, 1800mm	250-035-180
Ø 3.5mm, 2300mm	250-035-230
Ø 3.5mm, 3000mm	250-035-300
Ø 4.8mm, 1800mm	250-048-130
Ø 4.8mm, 2300mm	250-048-230
Ø 4.8mm, 3000mm	250-048-300



A



B



C



D



I



E



F



J



G



H



K



Adapter pieces for fiber light cable for use with light source

A SPiTZ/Storz	250-039-000
B Wolf	250-037-000
C ACMI/British Standard/CUDA	250-041-000
D Olympus	250-044-000
E Luxtec	250-048-000
F Heine	250-052-000
G Stryker	250-051-000
H Pentax	250-059-000

Adapter pieces for fiber light cable for use with telescope

I SPiTZ/Storz/Olympus	250-042-000
J Wolf	250-040-000
K ACMI/British Standard	250-041-000





LAP Suction and Irrigation Pump P1000 complete set
300-000-100V



Special filters ensure sterility

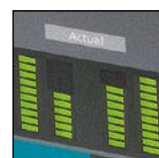

Digital display shows actual suction and irrigation pressures

- Features:
- Independently digital pre-setting for maximum suction and irrigation pressures
 - Digital display of actual suction and irrigation pressures
 - High efficiency with rates up to 3 L/minute
 - Color coded tubing sets
 - Skid-proof pedestals
 - Standby function
 - Low noise level
 - Optional footswitch for comfortable operation during surgery
 - Hydrophobic disposable filters for maximum patient safety
 - Stainless steel housing for maximum lifetime

- Delivery contains:
- Main Unit
 - Suction and Irrigation Tubing Set
 - Aspiration Bottle, 2L
 - 2 Retainers with screws
 - Puncture tube, 235mm
 - 2 Hydrophobic filters, sterile
 - Mains Cable
 - 2 Spare Fuses
 - Operating Manual



- Pump P1, 110 - 230V
- | | |
|--|--------------|
| For Arthroscopy | 225-906-000V |
| Irrigation Tubing Set, silicone, autoclavable (included) | 225-910-001 |
| Irrigation Tubing Set, PVC, 20 pcs. daily tube, sterile (optional) | 225-910-002 |
| Patient Tube, PVC, 40 pcs., sterile (optional) | 225-910-003 |

- Features:
- Hydrostatic pressure regulation
 - Silicone Tubing Set included (225-910-001)
 - Easy to operate, splash-proofed display
 - Highly reliable tube guide and handling
 - Skid-proof pedestals

Delivery contains:

- Main Unit
- Tubing Set
- Mains cable
- 2 Spare Fuses
- Operating manual



Airflow A2 Insufflation Device

Features:

- User-friendly interface
- Highest safety standard for patients
- Pre-insufflation mode for use with Veress Cannulas
- High gasflow rates

Delivery contains:

- Main Unit
- Sterile Filter 300-902-007
- Wrench Set 300-902-006
- CO₂ High Pressure Tube 300-902-003
- Standard Silicone Tube 300-902-005
- Mains Cable
- Operating Manual



Airflow A2
300-900-020V



Sterile Filter
300-902-007



Wrench Set (SW30/SW17)
300-902-006



CO₂ High Pressure Tube
300-902-003



Standard Silicone Tube
300-902-005



CO₂ Bottle, 0.75kg, empty (optional available)
300-902-008

Arthroscopy Shaver System STUNNER S1

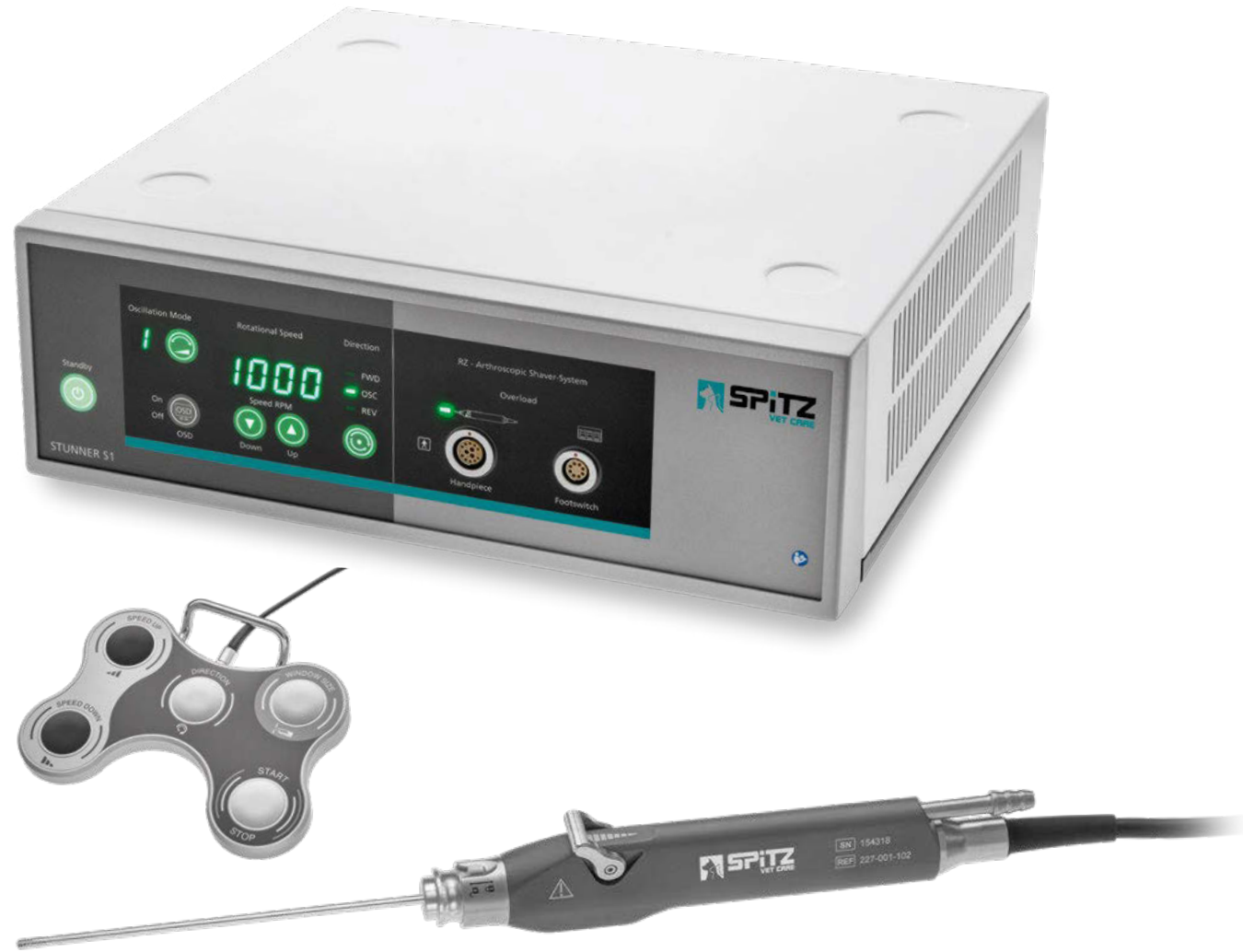

- Features:
- Open window calibration of shaver blades
 - 9 oscillation modes
 - Controlled by buttons on the handpiece or by footswitch
 - Fully autoclavable, small and ergonomic handpiece
 - Dedicated shaver blades

STUNNER S1 Unit, complete with Hand Piece and Footswitch	
110 - 230V	227-001-110V
Control Unit	
	227-001-101V
Hand Piece	
	227-001-102V
Footswitch	
	227-001-103V



Shaver Blades



DR PitBull Shaver Blades
The universal blade for soft and hard tissue



DR Waver Cutter Shaver Blades
The perfect blade for soft tissue resection

Non-sterile, 85mm working length	
Ø 3.0mm	227-016-013
130mm working length	
Ø 3.0mm	227-016-113
Ø 4.0mm	227-016-114

Non-sterile, 85mm working length	
Ø 2.0mm	227-016-002
Ø 3.0mm	227-016-003
130mm working length	
Ø 3.0mm	227-016-103
Ø 4.0mm	227-016-104



Lithotripter

Features:

- Energy transmission occur purely mechanically
- The smallest probe diameter is only 0.6mm, which ensures a larger lumen
- Auxiliary instruments can also be inserted
- Very simple handling, all parts are easy to disassemble for cleaning purposes
- Compatible to SPiTZ and other instruments for the therapy of ureteric, renal and bladder stones
- Non-conductive hand piece to ensure safety for patients as well as users against current conduct



Delivery contains:

- Main Unit
- Mains Cable
- Operating Manual



Lithotripter L100
253-750-100V



Litho Probe, 605mm working length

0.6mm	253-850-006
0.8mm	253-850-005
1.0mm	253-850-010
1.6mm	253-850-016
2.0mm, 450mm WL	253-850-020
2.5mm, 450mm WL	253-850-025



Footswitch

253-750-150



Hand piece, anodized

253-750-200



Air compressor, 4 bar maximum

(optional) 253-750-010

Medical Monitors



- All monitors feature:
- 178° viewing angle
 - Stand inclusive
 - Variety of video outputs

iLumen LED Endovue Monitor
1920 x 1200 pixels (WUXGA)

24" 300-001-158

1920 x 1080 pixels (FullHD)

21" 300-001-148

1280 x 1024 pixels (SXGA)

19" 300-001-138

Trolleys

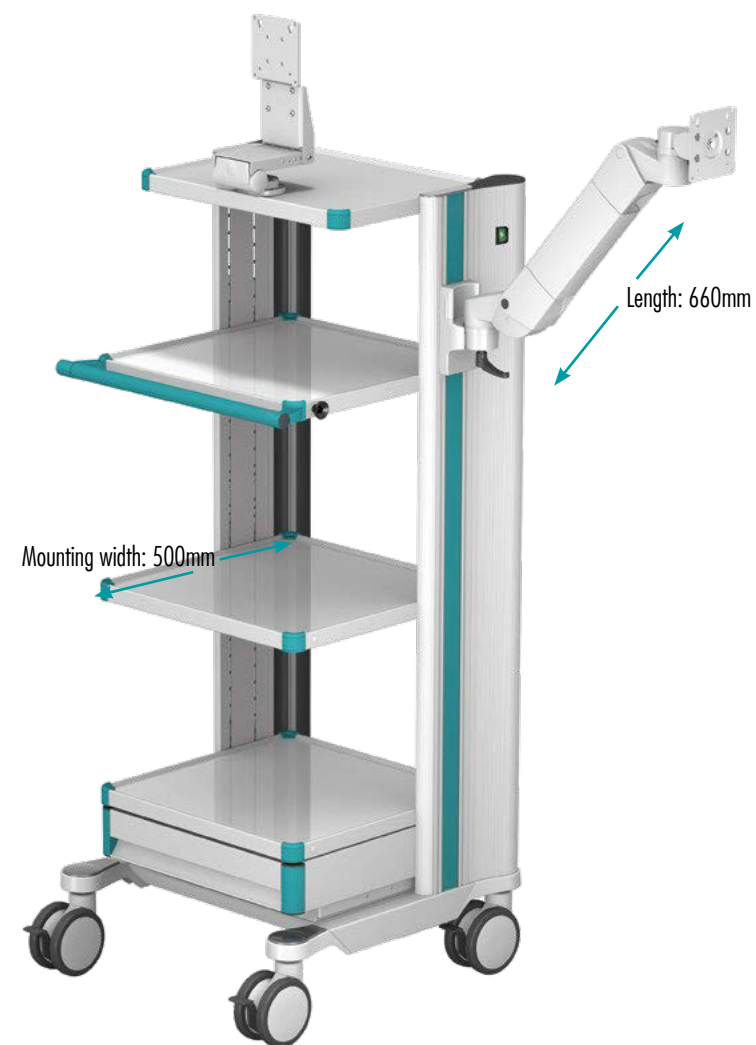

High-End Trolley

300-002-001

DIMENSIONS
1600 x 500 x 625mm
Rollers: Ø 125mm



Basic Trolley

300-001-999



SPITZ VET CARE

Unter Hasslen 20
78532 Tuttlingen, Germany

Phone: +49 7462 9470-75
Fax: +49 7462 9470-50

info@spitz.vet
www.spitz.vet